



**MICROSAFE®**

# Surgical Draping Systems

Premium quality. Efficiency. Variety.

## PRODUCT CATALOG 2023



**STERIL SAĞLIK URUNLERI  
SINCE 2011**

[www.sterilsaglik.com](http://www.sterilsaglik.com)

## Safety for You and Your Patients

Since 2011, STERIL SAGLIK URUNLERI (formerly known as Sengewald) has been a leading manufacturer of surgical draping systems in Turkey, specializing in the laminating and converting process. We are dedicated to developing innovative and user-friendly products that enhance the efficiency and safety of surgical procedures. With a proven track record of over 23 million drapes and 4 million packs produced, our commitment to quality is evident.

In the fast-paced environment of the operating theatre, every minute counts. That's why we offer a comprehensive range of MICROSAFE® complete draping systems, single drapes in various materials, and protective clothing to facilitate surgery preparation. With MICROSAFE®, you have the flexibility to create customized surgical procedure packs tailored to your specific needs. As a technological market leader, we possess the professional competence and flexibility to quickly adapt to changing market demands. Our solutions combine exceptional quality with optimal comfort, and our experienced staff is always available to provide expert guidance. Your satisfaction is our ultimate goal.

Quality "made in Turkey" is deeply ingrained in our company philosophy, and we strive to uphold it every day. We place utmost importance on maintaining and continuously improving all product and hygiene standards throughout the entire production process. Our commitment to compliance ensures your safety and the well-being of your patients.

Lastly, sustainability is a core value that we embrace. All materials used by STERIL SAGLIK URUNLERI are 100% free of PVC, emollients, and heavy metals, as we actively contribute to a healthier and more environmentally friendly future.

## Universal Drapes

Plain Drapes, Non-Adhesive	12
Aperture Drapes	14
Epidural Drapes, Adhesive	15 – 16
Adhesive Drapes	16 – 18
Split Sheets	19 – 20
Mayo Stand Covers	21
Back Table Covers	21

## General Surgery

Universal Packs	24 – 25
MIS Drapes	26
Rectum Drapes/Pack	27
Strumectomy Packs	28
Split Sheet Packs	29

## Cardio/Thoracic, Vascular Surgery

Cardio/Thoracic Drapes	32
Bypass Packs	33
Hybrid Drapes	34
Supplementary Products	35
Angiography Drapes	36 – 37

## Orthopaedics/Traumatology

Split Sheet Pack	40
Extremity Drapes	41
Extremity Packs	42
Arthroscopy Drapes	43
Arthroscopy Packs	44 – 45
Shoulder Drape	46
Hand Surgery Drapes	47
Hand/Foot Pack/Drapes	48
Hip Pack/Drape	49
Vertical Isolation Drapes/Packs	50
Supplementary Products	51 – 53

## Urology

Urology Drapes	56 – 57
Urology Packs	58
Split Sheets/DaVinci Drape	59
Small Drapes/Packs	60
Supplementary Products	61

## Gynaecology

GYN Drape/Pack	64
Pfannenstiel Drape/Pack	65
C-Section Drapes/Pack	66 – 67
GYN/LAP Drapes	68
Small Drapes	68 – 69

## Neurosurgery/ENT/OMS/Eyes

Neurosurgery Drapes	72
Laminectomy Drapes	73
Turban Drape	74
ENT Drapes	74
Eye Drapes	75 – 76
Supplementary Products	77

## Paediatrics

Paediatrics Drapes/Pack	80 – 81
-------------------------	---------

## Day Surgery

General Surgery	84 – 85
Traumatology and Orthopaedic Surgery	86 – 88
Aperture Drapes/Packs	89
Gynaecology/Urology	90 – 91
Plain Drapes	92
Adhesive Drapes	92
Aperture Drapes	93

Supplementary Products	94
Variable Aperture Drapes/Spit Sheet Pack	95

## Supplementary Products

Fluid Collection/Diathermy Pouches	98
Velcro Strip/OR Tapes/Incision Film	99
Foot Covers/Stockinettes/Leggings	100
Camera-/Image Intensifier Covers	101
Equipment Covers	102 – 103
Accessory	104 – 105

## OR Gowns

OR Gowns Standard/Reinforced	108 – 111
------------------------------	-----------

## Protection Products (Non-sterile)

Scrub Suits/Non-Woven Jackets	114
Protection/Visitor Gown	115
Accessory	116
Protection Sheets/Aprons/Examination Couch Covers	117

## The Premium Quality Material

### Mediwell super strong - Symbiosis of comfort and functionality

#### The basic non-woven

- ✓ Pleasantly soft and extremely absorbent
- ✓ The typical orange skin structure binds fluids of over 6 times own weight

#### The protective film

- ✓ Perfect barrier against microbes
- ✓ Super soft and absolutely impermeable to fluids
- ✓ The patient remains dry and is safely protected from infections
- ✓ The film is extremely lightweight and nevertheless highly tear resistant

#### The patient layer

- ✓ The non-woven is especially soft and durable
- ✓ Thanks to the lamination technology with the tiny air cushions it lies even more pleasantly on the skin and provides maximum patient comfort

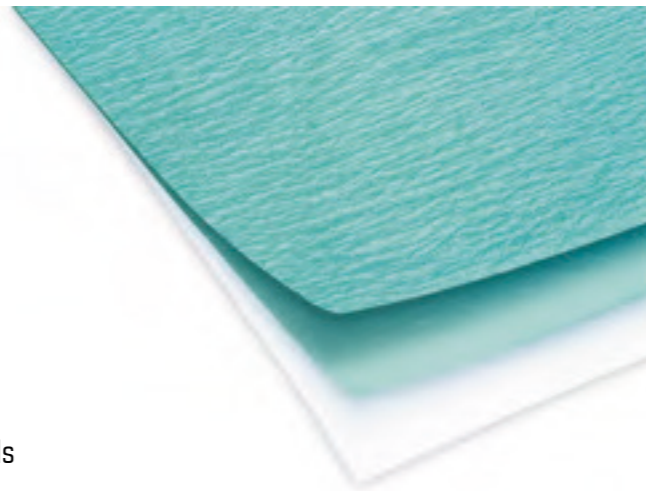

## Custom Procedure Trays (CPT)

### Custom-made solutions for your surgical application

Since more than 12 years MICROSAFE® systems from Sengewald combine individuality and standardisation in the OR: 4 million customer-specific packs leave our production facilities per year in more than 2,000 different configurations. We are happy to support you from the initial consultation up to the adoption of your individual pack in the daily routine in the operating theatre. Alternatively packs can also be selected or modified from our catalogue. Thereby, every component contained in the tray can be tracked back – through this flexibility meets premium quality and absolute material safety.

#### Our effort – your profit:

- ✓ Competent support in defining the pack contents
- ✓ Indication related and individual composition
- ✓ Process standardisation
- ✓ Increase of efficiency in the OR
- ✓ Absolute cost transparency
- ✓ Less storage space requirement
- ✓ Minimisation of waste



- Our products fulfil the highest requirements:
- ✓ High tensile strength
  - ✓ High absorption capacity
  - ✓ Impervious to bacteria and fluids
  - ✓ PP non-woven for maximum patient comfort
  - ✓ Latex-free

## Multiple Layer

### Mediwell

2 or 3-ply material combination; absorbent and impervious to bacteria and fluids, HP.

**Uses:** as back table covers or a sterile field, patient drapes for minor procedures with low fluid incidence, as a bottom drape.



### Mediwell super

2 or 3-ply material combination; extremely high absorbent capacity, impervious to bacteria and fluids, HP.

**Uses:** as back table covers, patient drapes for medium to major procedures, as a bottom drape.



### Mediwell super strong

3-ply material combination; extremely high absorbent capacity and highly tear resistant, impervious to bacteria and fluids, HP.

**Uses:** as patient drapes for medium to major procedures with high fluid incidence.

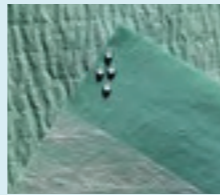

### Mediwell absorb

2-ply material combination; as a reinforcement non-woven with high absorptive capacity, very great wet rub-resistance, impervious to bacteria and fluids, HP.

**Uses:** as a reinforcement for angiography drapes and mayo stand covers as well as for custom drapes for procedures with a very high fluid incidence and/or subject to extremely great demands, also available as freely applicable adhesive drapes.



### aquamarine

2 or 3-ply material combination; very absorbent and exceedingly tear resistant, impervious to bacteria and fluids, HP.

**Uses:** as back table covers, patient drapes for all procedures.



All multiple and single layer materials are also available in packs that can be completely individually compiled according to your requirements. So you are best prepared for complex interventions.

Our products thereby exceed all the requirements of EN 13795 and bear the CE label according to EC directive 93/42 EEC medical devices.

## Single-Ply

### Mediwell soft

Soft non-woven material, particularly similar to textiles; low-linting, alcohol and fluid-repellent, breathable, very comfortable to wear, SP.

**Uses:** as a patient drape for ophthalmic surgery, scrub suits, jackets and OR gowns.

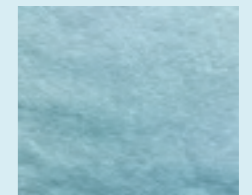

### Mediwell light

Light SMMMS non-woven; alcohol and fluid-repellent, breathable, comfortable to wear, SP.

**Uses:** as a patient drape for ophthalmic surgery, OR gowns.



### Filmdrape

Contact transparency, micro-embossed, very drapeable PE film; impervious to bacteria and fluids, HP.

**Uses:** as a patient drape for minor and medium procedures in anaesthesia and ophthalmology.

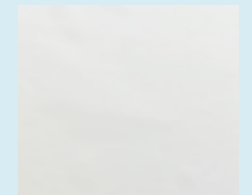

### Colordrape

Very drapeable PE coex film, impervious to bacteria and fluids, turquoise-coloured, HP.

**Uses:** special applications as patient drapes or as reinforcement in high-performance OR gowns.



HP: fulfils the requirements of EN 13795 for High Performance  
SP: fulfils the requirements of EN 13795 for Standard Performance

# Universal Drapes



Regardless of which intervention you undertake: Our extensive range of universal drapes and back table cover guarantee you maximum flexibility and optimum hygiene. We offer precisely the right solution for every area of application – also custom-made according to your individual requirement.

Our portfolio comprises various models for secure and reliable draping of the patient and the surrounding area in surgical procedures. From standard drapes for day surgeries up to drapes for surgical interventions with large amounts of fluids and highest requirements.



# Universal Drapes

## Plain Drapes

Mediwell 2-ply	Qty. dispenser or inliner/PU	Size/cm	Ref. no.
	120 / 720	37,5 x 45	503842
	70 / 420	45 x 75	504572
	45 / 270	75 x 90	507592
	25 / 75	100 x 150	509215
Mediwell 3-ply			
	<del>65 / 390</del>	45 x 75	504575 X delete
	35 / 210	75 x 90	507590
	<del>20 / 60</del>	100 x 150	509015 X delete
	15 / 45	150 x 180	501518-9 non-sterile
	10 / 30	150 x 240	501524

Mediwell super 2-ply	Qty. dispenser or inliner/PU	Size/cm	Ref. no.
	60 / 360	45 x 75	508825
	40 / 240	75 x 90	508824
	30 / 180	100 x 100	508858
	20 / 60	100 x 150	508823
	15 / 45	150 x 180	508821
	Pack component	175 x 200	508878-9
	Pack component	200 x 280	508827-9

Mediwell super 3-ply	Qty. dispenser or inliner/PU	Size/cm	Ref. no.
	<del>30 / 360</del>	45 x 75	508805 X delete
	30 / 180	75 x 90	508804

Mediwell super strong 3-ply	Qty. dispenser or inliner/PU	Size/cm	Ref. no.
	20 / 60	100 x 150	508803
	11 / 33	150 x 180	508801
	Pack component	150 x 200	508857-9
	10 / 30	150 x 240	508802

aquamarine 3-ply	Qty. dispenser or inliner/PU	Size/cm	Ref. no.
	<del>8 / 24</del>	200 x 200	808879 X delete
aquamarine 2-ply			
	27 / 81	100 x 150	808823
	18 / 54	150 x 140	808844-9 non-sterile
	16 / 48	150 x 180	808821
	14 / 42	150 x 200	808869
	12 / 36	150 x 220	808816-9 non-sterile
	10 / 30	150 x 250	808819-9 non-sterile

Filmdrape	Qty. dispenser or inliner/PU	Size/cm	Ref. no.
	Pack component	150 x 200	506620-9

Mediwell soft Baby Sheet	Qty. dispenser or inliner/PU	Size/cm	Ref. no.
	Pack component	90 x 86	585758-9
	30 / 104	100 x 150	585764
	Pack component	120 x 120	585761-9
	Pack component	150 x 130	505712-9

## Aperture Drapes

Mediwell 2-ply	Qty. dispenser or inliner/PU	Size/cm	Ref. no.
Aperture Ø 6 cm, central	70 / 420	45 x 75	514572
Aperture Ø 6 cm, central	45 / 270	75 x 90	517592
<b>Mediwell 3-ply</b>			
Aperture Ø 6 cm, central	50 / 300	45 x 75	514575
<del>Aperture Ø 6 cm, central</del>	30 / 180	75 x 90	517590 delete
<b>Mediwell super 2-ply</b>			
Aperture Ø 6 cm, central	70 / 420	45 x 75	518821
Aperture Ø 6 cm, central	45 / 270	75 x 90	518822

## Aperture Drapes, Adhesive

Mediwell 2-ply	Qty. dispenser or inliner/PU	Size/cm	Ref. no.
Aperture oval, 5 x 7.5 cm, central	65 / 390	50 x 60	555064
<b>Mediwell super 2-ply</b>			
Aperture Ø 6 cm, central	70 / 420	50 x 60	558823
Aperture Ø 6 cm, central	45 / 270	75 x 75	558971
Aperture oval, 8 x 6 cm, central	40 / 240	75 x 90	558972
Aperture oval, 7 x 10 cm, central	25 / 75	100 x 150	558974
<b>Mediwell super strong 3-ply</b>			
Aperture 15 x 15 cm, central	18 / 54	120 x 150	559075
Aperture 7.5 x 5 cm, decentral	15 / 45	120 x 150	558801 not in the print catalogue
Adhesive aperture Ø 13 cm, central	12 / 24	200 x 240	559175 not in the print catalogue
<b>Filmdrape</b>			
Aperture Ø 6 cm, central	50 / 150	75 x 130	556655 S-special production

## Variable Aperture Drapes, Adhesive, 2-Part

Mediwell super 2-ply	Qty. dispenser or inliner/PU	Size/cm	Ref. no.
Aperture max. 12 x 21 cm	50 / 300	50 x 75	554575
Aperture max. 12 x 21 cm	35 / 210	75 x 90	558948
Aperture max. 18 x 28 cm	30 / 180	75 x 90	558964

## Epidural Drapes

Mediwell 2-ply	Qty. dispenser or inliner/PU	Size/cm	Ref. no.
Aperture ◇ 10 x 10 cm, decentral, with adhesive zone 6 x 57 cm	50 / 300	57 x 72	555772
<b>Mediwell super 2-ply</b>			
Aperture Ø 10 cm, decentral, with adhesive zone 6 x 60 cm	Pack component	60 x 75	558838-9
Aperture Ø 10 cm, decentral, adhesive, with adhesive zone 6 x 60 cm	40 / 240	60 x 75	558839
Aperture Ø 10 cm, central, adhesive, with adhesive zone 6 x 75 cm	30 / 180	75 x 75	558989
Aperture oval, 15 x 18 cm, decentral, adhesive, with adhesive zone 5.5 x 75 cm	20 / 60	75 x 100	558991

Mediwell super with transparent film fenestration and perforation	Qty. dispenser or inliner/PU	Size/cm	Ref. no.
Film window 35 x 35 cm, central, 10 cm central adhesive aperture, and adhesive zone 6 x 75 cm	45 / 135	75 x 75	558846
Film window 35 x 35 cm, central, 12 cm central adhesive aperture, and adhesive zone 6 x 75 cm	45 / 135	75 x 75	558848 delete
Film window 35 x 35 cm, central, 10 cm central adhesive aperture, and adhesive zone 6 x 75 cm	35 / 105	75 x 100	558847
Film window 35 x 35 cm, central, 12 cm central adhesive aperture, and adhesive zone 6 x 75 cm	35 / 105	75 x 100	558849

Mediwell super CVC drape	Qty. dispenser or inliner/PU	Size/cm	Ref. no.
Film window 35 x 35 cm, decentral, 9 cm central adhesive aperture	12 / 36	120 x 150	558975

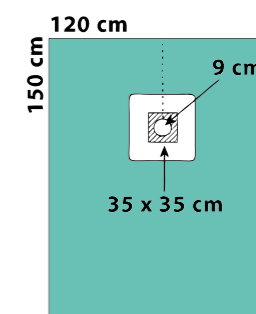
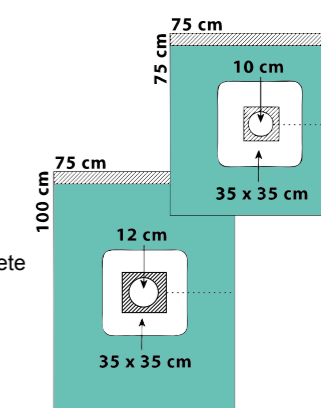
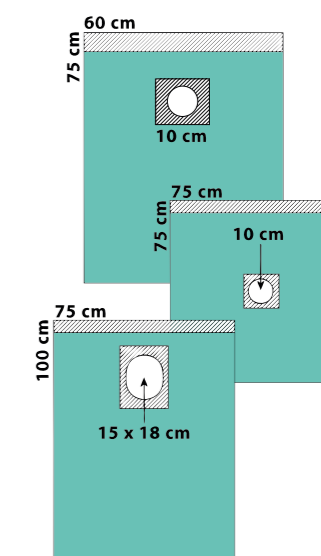
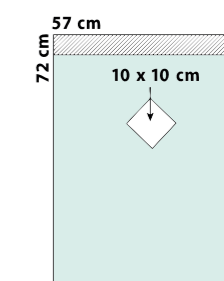



# Universal Drapes

## Epidural Drapes

### Filmdrape

Aperture Ø 10 cm, decentral, adhesive, with adhesive zone 6 x 60 cm

Qty. dispenser or inliner/PU	Size/cm	Ref. no.
50 / 150	60 x 100	556654

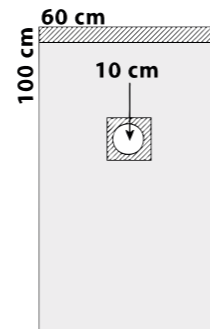

## Adhesive Drapes

### Mediwell super 2-ply

	Qty. dispenser or inliner/PU	Size/cm*	Ref. no.
Adhesive zone 5 x 50 cm	70 / 420	50 x 50	538822
Adhesive zone 5 x 75 cm	65 / 390	50 x 75	538829
Adhesive zone 5 x 75 cm	45 / 270	75 x 75	538821
Adhesive zone 5 x 90 cm	40 / 240	75 x 90	538823
Adhesive zone 5 x 90 cm	Pack component	<u>90</u> x 150	538834-9

### Mediwell super 3-ply

Adhesive zone 5 x 50 cm	80 / 480	50 x 50	538802
Adhesive zone 5 x 75 cm	<del>50 / 300</del>	50 x 75	538809 <del>X delete</del>
Adhesive zone 5 x 75 cm	35 / 210	75 x 75	538801
Adhesive zone 5 x 90 cm	30 / 180	75 x 90	538803

### Mediwell super strong 3-ply

	Qty. dispenser or inliner/PU	Size/cm*	Ref. no.
Adhesive zone 5 x 100 cm	30 / 90	75 x 100	538811
Adhesive zone 5 x 100 cm	20 / 60	100 x 100	538813
Adhesive zone 5 x 100 cm	22 / 66	150 x <u>100</u>	538886
Adhesive zone 5 x 80 cm	10 / 30	150 x <u>180</u>	538805
Adhesive zone 5 x 80 cm	10 / 30	150 x <u>240</u>	538807
Adhesive zone 5 x 80 cm	9 / 27	175 x <u>180</u>	538806
Adhesive zone 5 x 240 cm, 3-part 69 / 102 / 69 cm	5 / 20	175 x <u>240</u>	538898
Adhesive zone 5 x 120 cm	5 / 15	175 x <u>300</u>	538808
Adhesive zone 5 x 80 cm	8 / 24	200 x <u>180</u>	538810

\* Underlined numbers mark the adhesive side

## Adhesive Drapes

### Mediwell absorb 2-ply

	Qty. dispenser or inliner/PU	Size/cm*	Ref. no.
Adhesive drape absorbent, adhesive zone 5 x 75 cm	30 / 180	50 x 75	538889
Adhesive drape absorbent, adhesive zone 5 x 50 cm	40 / 240	75 x <u>50</u>	538887
Adhesive drape absorbent, adhesive zone 16 x 90 cm	35 / 105	75 x 90	538888

### aquamarine 2-ply

Adhesive zone 5 x 90 cm	<del>25 / 150</del>	<del>100 x <u>90</u></del>	<del>838835</del>
-------------------------	---------------------	----------------------------	-------------------

### aquamarine 3-ply

Adhesive zone 5 x 80 cm	<del>10 / 30</del>	<del>150 x <u>100</u></del>	<del>838803</del>
Adhesive zone 5 x 80 cm	<del>8 / 24</del>	<del>150 x <u>240</u></del>	<del>838807</del>
Adhesive zone 5 x 80 cm	<del>10 / 30</del>	<del>175 x <u>180</u></del>	<del>838806</del>
Adhesive zone 5 x 120 cm	<del>Pack component</del>	<del>175 x <u>300</u></del>	<del>838808-9</del>
Adhesive zone 5 x 120 cm	<del>Pack component</del>	<del>250 x <u>300</u></del>	<del>838809-9</del>

# Universal Drapes

## Adhesive Drapes with Special Adhesive for Sensitive Skin

Mediwell super 3-ply	Qty. dispenser or inliner/PU	Size/cm	Ref. no.
Adhesive zone 2.5 x 50 cm	Pack component	75 x <u>50</u>	538912-9

Mediwell super strong 3-ply with 2.5 cm adhesive zone	Qty. dispenser or inliner/PU	Size/cm*	Ref. no.
Adhesive zone 2.5 x 100 cm	40 / 120	75 x <u>100</u>	538914
Adhesive zone 2.5 x 80 cm	Pack component	175 x <u>180</u>	538916-9
Adhesive zone 2.5 x 80 cm	Pack component	150 x <u>240</u>	538917-9

Mediwell super strong 3-ply with 5 cm adhesive zone	Qty. dispenser or inliner/PU	Size/cm*	Ref. no.
Adhesive zone 5 x 100 cm	Pack component	75 x <u>100</u>	538915-9
<del>Adhesive zone 5 x 120 cm</del>	40 / 120	100 x <u>120</u>	538944 delete
Adhesive zone 5 x 80 cm	Pack component	150 x <u>240</u>	538918-9
Adhesive zone 5 x 80 cm	Pack component	175 x <u>180</u>	538943-9
Adhesive zone 5 x 180 cm, 2-part 90 / 90	Pack component	175 x <u>180</u>	538920-9
Adhesive zone 5 x 300 cm, 3-part 90 / 120 / 90	Pack component	175 x <u>300</u>	538942-9

## Split Sheets

Mediwell super 2-ply	Qty. dispenser or inliner/PU	Size/cm	Ref. no.
U-slit 7 x 40 cm, adhesive	25 / 150	75 x 90	528855
U-slit 7 x 30 cm, adhesive	<del>20 / 180</del>	90 x 75	528866 X delete

Mediwell super strong 3-ply	Qty. dispenser or inliner/PU	Size/cm*	Ref. no.
U-slit 7.5 x 45 cm, adhesive	15 / 45	120 x <u>150</u>	528801
U-slit 7.5 x 65 cm, adhesive	10 / 30	160 x <u>200</u>	528802
U-slit 7.5 x 65 cm, with special adhesive for sensitive skin	7 / 14	<u>200</u> x 260	528815
U-slit 7.5 x 100 cm, adhesive	7 / 14	<u>200</u> x 260	528805
U-slit 7.5 x 100 cm, adhesive, with perineal drape	8 / 16	<u>200</u> x 260	528806
U-slit 7.5 x 100 cm, adhesive	6 / 12	<u>225</u> x 320	528808

Colordrape	Qty. dispenser or inliner/PU	Size/cm*	Ref. no.
U-slit 7.5 x 50 cm, adhesive	18 / 54	<u>150</u> x 180	529901

Filmdrape	Qty. dispenser or inliner/PU	Size/cm*	Ref. no.
U-slit 7.5 x 50 cm, adhesive	25 / 75	125 x <u>150</u>	526601

## Split Sheet, Bilateral

Mediwell super strong 3-ply	Qty. dispenser or inliner/PU	Size/cm*	Ref. no.
U-slit, dual 40 x 100 cm, adhesive	15	<u>225</u> x 240	528869

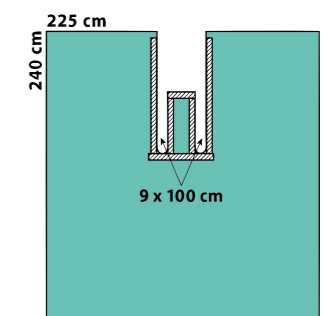

\* Underlined numbers mark the adhesive side

\* Underlined numbers mark the side with the slit

# Universal Drapes

## Split Sheet with Film Strips

Mediwell super strong 3-ply	Qty. dispenser or inliner/PU	Size/cm	Ref. no.
U-slit, U=7.5 x 100 cm, special adhesive for sensitive skin, 2 film strips 70 x 340, transparent	Pack component	<u>240</u> x 340	528839-9

## Split Aperture Drape

Mediwell 2-ply	Qty. dispenser or inliner/PU	Size/cm	Ref. no.
Aperture Ø 6 cm, central, slit 27 cm	Pack component	60 x 60	520057-9

\* Underlined numbers mark the side with the slit

## Mayo Stand Covers, Back Table Covers

### Colordrape

Mayo stand covers made of PE film	Qty. dispenser or inliner/PU	Size/cm	Ref. no.
"Standard", non-woven area 75 x 64 cm, turquoise	20 / 60	80 x 145	547714
"Special", 2-ply Mediwell super, reinforced area 75 x 64 cm	20 / 60	80 x 145	547716
"Super", 2-ply Mediwell absorb area, 75 x 74 cm, for heavy instruments, e.g. orthopaedic procedures, blue	18 / 54	80 x 145	547718

### aquamarine

Back table covers/Plain drapes, 2-ply	Qty. dispenser or inliner/PU	Size/cm	Ref. no.
	27 / 81	100 x 150	808823
	18 / 54	150 x 140	808844 -9 non-sterile
	16 / 48	150 x 180	808821
	14 / 42	150 x 200	808869
	12 / 36	150 x 220	808816 -9 non-sterile
	10 / 30	150 x 250	808819 -9 non-sterile

### Basic Pack

PU: 36 packs

Cont. and sequence	Size/cm	Qty.	Ref. no.
Overwrap	60 x 70	1	626870
Plain drape – table cover (wrap)	150 x 200	1	808869
Mayo stand cover	80 x 145	1	547714
Hand towels	25 x 20	2	-/-
OR tape, elastic	10 x 50	1	591151

### 563743 S- special production

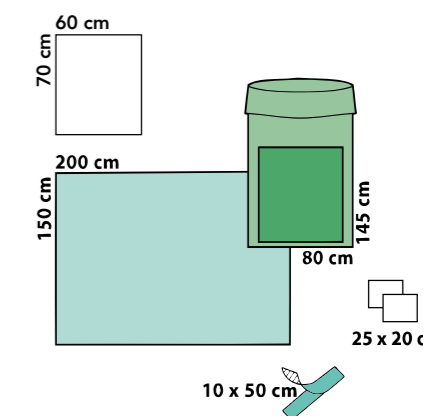

# General Surgery



Efficient and safe – from a basic surgical pack up to all-in-one drapes for minimally invasive procedures and complex positioning of the patient.

Our drapes offer high functionality, allow more efficient procedures and guarantee optimum protection of the patient.



## Universal Packs

### Universal Pack, standard **561088**

PU: 7 packs

Cont. and sequence	Size/cm	Qty.	Ref. no.
Plain drape – table cover (wrap)	150 x 200	1	808869
Mayo stand cover	80 x 145	1	547714
Hand towels	25 x 20	4	-/-
OR tape	10 x 50	1	591050
Side drape	75 x 100	2	538811
Foot drape	175 x 180	1	538806
Head drape	150 x 240	1	538807

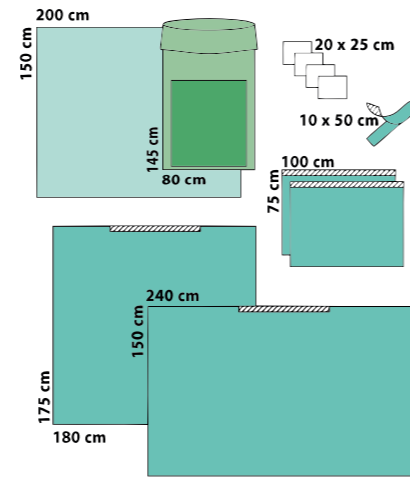

### Universal Pack, paediatrics **561007**

PU: 7 packs

Cont. and sequence	Size/cm	Qty.	Ref. no.
Plain drape – table cover (wrap)	150 x 200	1	808869
Mayo stand cover	80 x 145	1	547714
Hand towels	25 x 20	4	-/-
OR tape, elastic	10 x 50	1	591151
Side drape	75 x 100	2	538914
Foot drape	175 x 180	1	538916
Head drape	150 x 240	1	538917

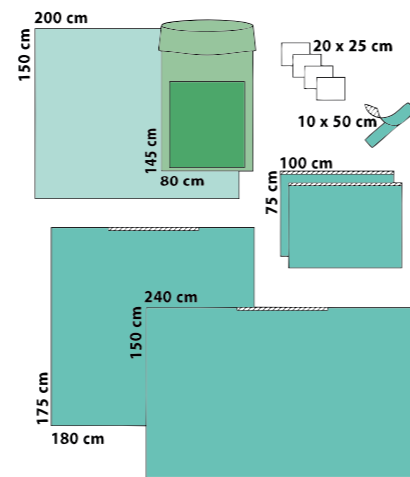

Particularity: with special adhesive and 2.5 cm narrow adhesive zones for children`s skin.

### Universal Pack, super **561009**

PU: 7 packs

Cont. and sequence	Size/cm	Qty.	Ref. no.
Plain drape – table cover (wrap)	150 x 200	1	808869
Mayo stand cover	80 x 145	1	547714
Hand towels	25 x 20	4	-/-
OR tape	10 x 50	1	591050
Side drape	75 x 100	2	538811
Foot drape	175 x 180	1	538806
Head drape	175 x 300	1	538808

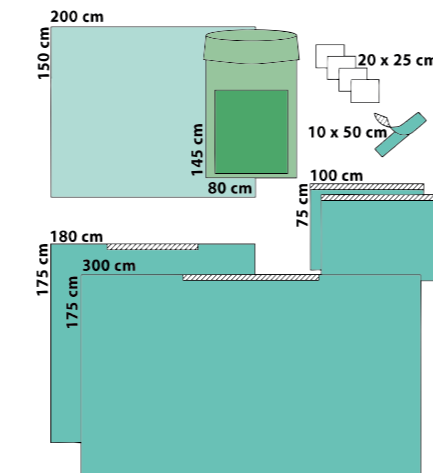

Particularity: with larger head drape

### Universal Pack, super + **561027**

PU: 7 packs

Cont. and sequence	Size/cm	Qty.	Ref. no.
Plain drape – table cover (wrap)	150 x 200	1	808869
Mayo stand cover	80 x 145	1	547714
Hand towels	25 x 20	4	-/-
OR tape	10 x 50	2	591050
Side drape	100 x 100	2	538813
Foot drape	175 x 180	1	538806
Head drape	175 x 300	1	538808

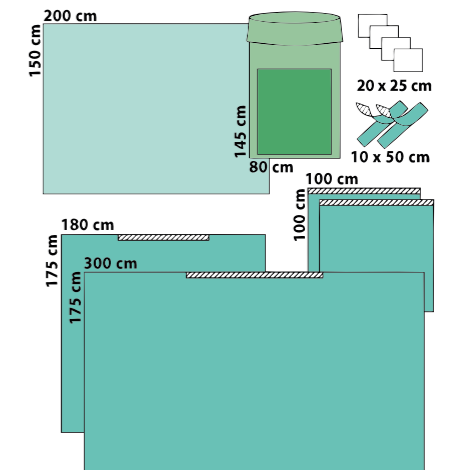

Particularity: with larger back table cover, side drapes, head drapes and additional OR tape

### Universal Pack, aquamarine ~~delete~~ **861088**

PU: 8 packs

Cont. and sequence	Size/cm	Qty.	Ref. no.
Plain drape – table cover (wrap)	150 x 200	1	808869
OR tape	10 x 50	1	591050
Hand towels	25 x 20	2	-/-
Mayo stand cover	80 x 145	1	547714
Side drapes, 2-ply	75 x 90	2	838823
Foot drape	180 x 175	1	838806
Head drape	150 x 240	1	838807

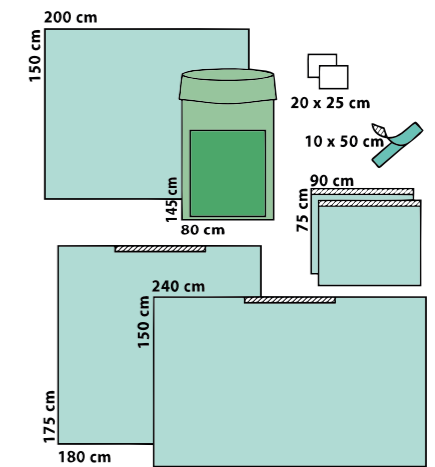

Last sales 2017

### Universal Pack Mini **564340**

PU: 16 packs

Cont. and sequence	Size/cm	Qty.	Ref. no.
Plain drape – table cover (wrap)	100 x 150	1	808823
Adhesive drapes, 2-ply	75 x 90	4	538823

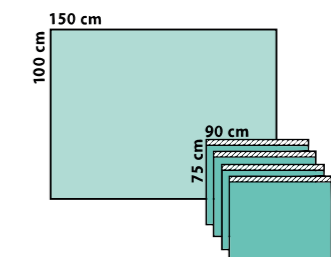

## MIS Drapes

### MIS Drape **558806-9**

Description	Size/cm
MIS drape, 29 x 32 cm aperture, adhesive	225 x 320

Only available as a non-sterile pack component

### MIS Drape with leggings **558884**

Inliner/PU: 7 drapes

Description	Size/cm	Qty.	Ref. no.
MIS drape, 29 x 32 cm aperture, adhesive	225 x 320	1	558884
OR tapes	10 x 50	4	591050
Velcro strips	2/2.5 x 24	2	592525

### MIS Pack **563852**

PU: 6 packs

Cont. and sequence	Size/cm	Qty.	Ref. no.
Plain drape – table cover (wrap)	150 x 200	1	808869
Mayo stand cover	80 x 145	1	547714
MIS drape with leggings, 29 x 32 cm aperture, adhesive, with integral diathermy pouches, 30 x 50 cm.	225 x 320	1	558875
OR tape	10 x 50	4	591050
Velcro strips	2.5 x 25	2	592525

### MIS Drape T-Form **558876-9**

Description	Size/cm
MIS drape with leggings, anaesthesia part with OR tape to fix, 29 x 32 cm aperture, adhesive with 4 integral velcro strips	280/225 x 350

Only available as a non-sterile pack component

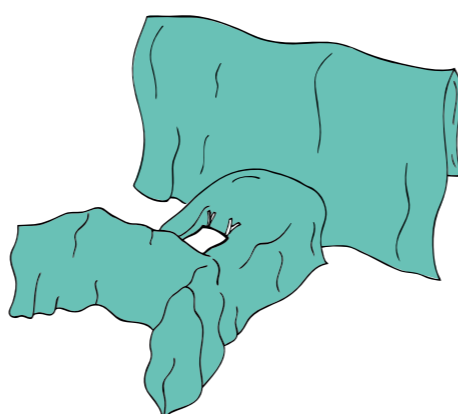
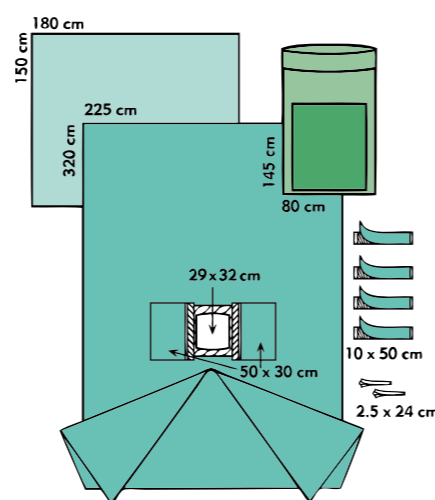
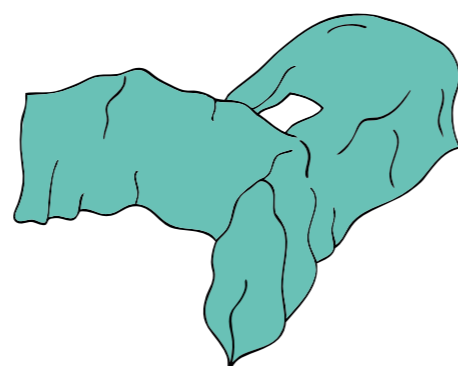
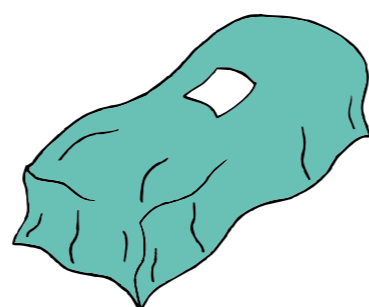

## Rectum Drapes and Pack

### Rectum with leggings **558885-9**

Description	Size/cm	Qty.	Ref. no.
Rectum drape with leggings, 37 x 37 cm adhesive fenestration and non-adhesive 14 x 16 cm perineal aperture with protective curtain	225 x 320	1	558885

OR tape, transparent, with 7 x 9 cm aperture to reduce in size and securely fix the perineal aperture	20 x 25		592125
---	---------	--	--------

Adhesive drape, 2-ply	50 x 50	1	538822
-----------------------	---------	---	--------

Only available as a non-sterile pack component

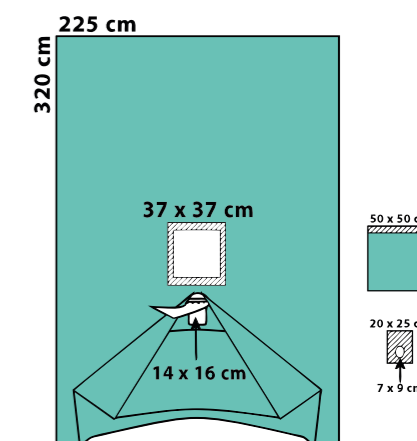

### Rectum Drape T-Form **558869-9**

Description	Size/cm
Rectum drape with leggings, aperture 29 x 32 cm, adhesive, 2 integral diathermy pouches, with non-adhesive perineal aperture 9 x 17 cm with protective curtain	280/225 x 350

Only available as a non-sterile pack component

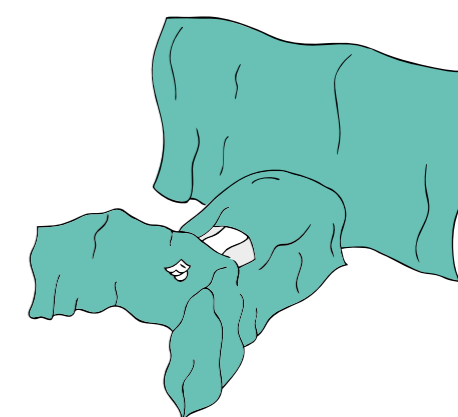

### Rectum Pack with leggings **561030**

PU: 12 packs

Cont. and sequence	Size/cm	Qty.	Ref. no.
Plain drape – table cover (wrap)	150 x 200	1	808869
Mayo stand cover	80 x 145	1	547714
Hand towels	20 x 25	2	-/-
OR tapes	10 x 50	4	591050
OR tapes	5 x 12.5	4	590512
Rectum drape with leggings, adhesive 29 x 32 cm aperture, and 9 x 9 cm non-adhesive perineal aperture with protective curtain	225 x 320	1	558867

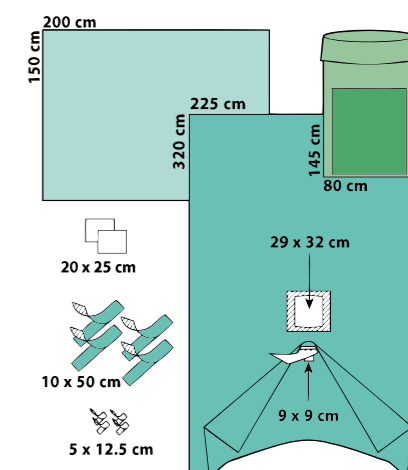

## Strumectomy Packs

### Strumectomy Pack, standard **561302**

PU: 8 packs

Cont. and sequence	Size/cm	Qty.	Ref. no.
Plain drape – table cover (wrap)	150 x 200	1	808869
Mayo stand cover	80 x 145	1	547714
Hand towels	25 x 20	4	-/-
OR tape	10 x 50	1	591050
Velcro strip, adhesive	2/2.25 x 24	1	592525
Foot drape	180 x 200	1	538810
Split sheet, U=65 cm	150 x 280	1	528804

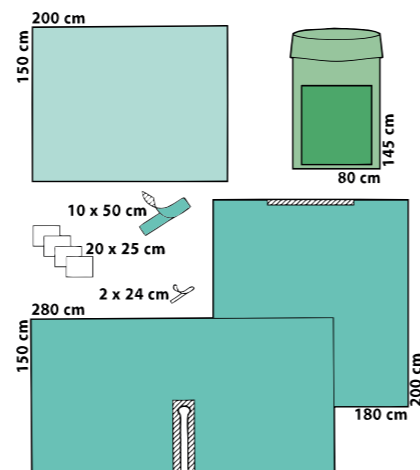

### U-Drape Pack 1 **561119**

PU: 10 packs

Cont. and sequence	Size/cm	Qty.	Ref. no.
Plain drape – table cover (wrap)	150 x 200	1	808869
Hand towel	25 x 20	1	-/-
Mayo stand cover	80 x 145	1	547714
Split sheet, U=7.5 x100 cm	200 x 300	1	528863
Split sheet, U=65 x 45 cm	150 x 270	1	528864

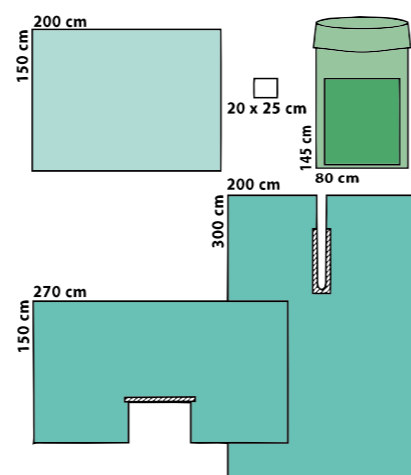

### U-Drape Pack 2 **563770**

PU: 10 packs

Cont. and sequence	Size/cm	Qty.	Ref. no.
Plain drape – table cover (wrap)	150 x 200	1	808869
Mayo stand cover	80 x 145	1	547714
Hand towel	25 x 20	1	-/-
Split sheet, U=30 x 80 cm	200 x 300	1	528816
Split sheet, U=65 x 45 cm	150 x 270	1	528864

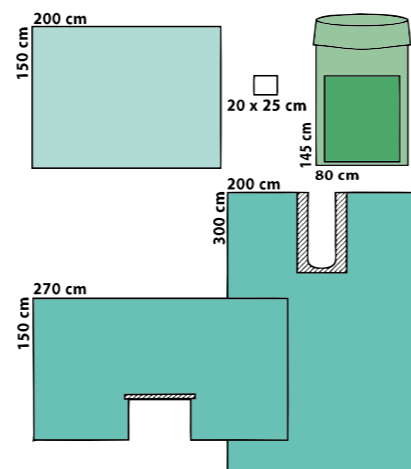

## Split Sheet Packs

### Split Sheet Pack, standard **561112**

PU: 7 packs

Cont. and sequence	Size/cm	Qty.	Ref. no.
Plain drape – table cover (wrap)	150 x 200	1	808869
Mayo stand cover	80 x 145	1	547714
Hand towels	25 x 20	4	-/-
Bottom drape, Mediwell 3-ply	150 x 180	1	501518
Split sheet, U=7.5 x 100 cm	200 x 260	1	528805
Adhesive drape	150 x 240	1	538807

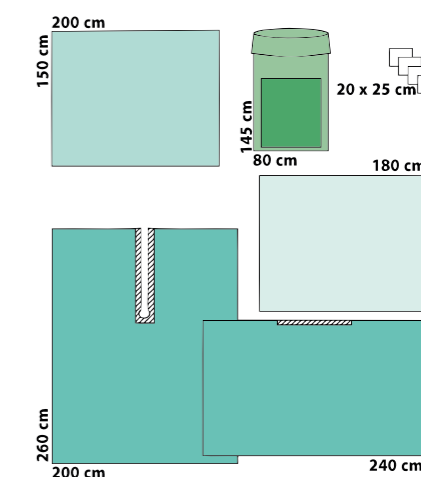

### Split Sheet Pack, Super **564371**

PU: 8 packs

Cont. and sequence	Size/cm	Qty.	Ref. no.
Plain drape – table cover (wrap)	150 x 200	1	808869
Mayo stand cover	80 x 145	1	547714
Bottom drape, Mediwell 3-ply	150 x 180	1	501518
Split sheet, U=7.5 x 100 cm	225 x 320	1	528808
Adhesive drape	175 x 300	1	538808
Hand towels	25 x 20	2	-/-

S-special production

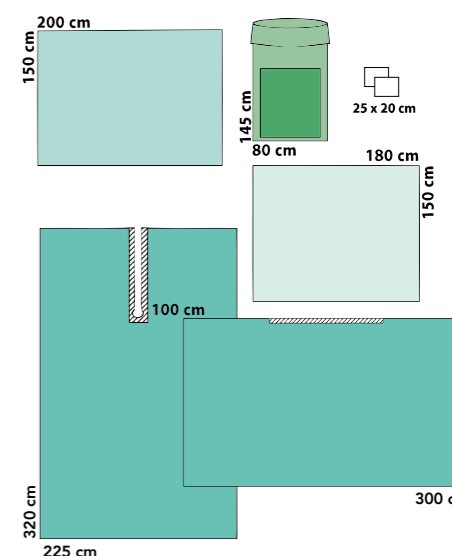

Hier Text eingeben

## Cardio/Thoracic, Vascular Surgery



With heart and mind: Our cardiovascular solutions fulfil the highest quality requirements in heart surgery. Innovative OR drapes provide optimum flexibility and safety – for established and for new surgical methods e.g. hybrid surgery.

Standard and customised OR drapes for angiography complete our product portfolio.

You will find further products in our separate cardio-surgery and angiography brochure.





You will find further products in our separate cardio-surgery and angiography brochure.

## Cardio/Thoracic Drapes

### Cardio/Thoracic Drape

**558914**

PU: 4 drapes

Description	Size/cm
T-form, anaesthesia part with double film thickness, 3 integral adhesive strips to fix 33 x 28 cm diathermy pouch and clamp strip. Thoracic part with 33 x 40 cm fenestration with integral incision film, 2 triple chamber diathermy pouches and 50 x 50 cm adhesive drape.	300/225 x 300

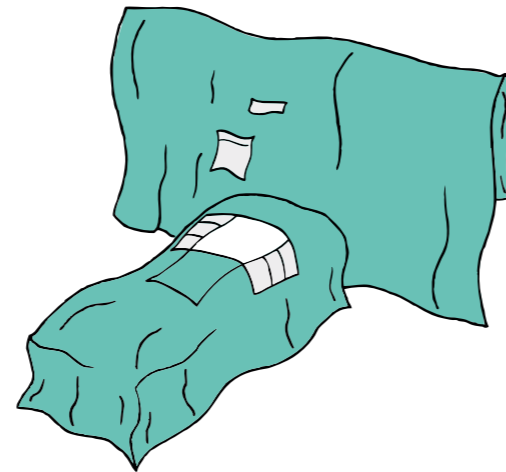

### Cardio/Thoracic Drape

**558993-9**

Description	Size/cm	Qty.	Ref. no.
T-form, anaesthesia part with double film thickness, 3 integral adhesive strips to fix, 2 velcro fasteners and reinforced clamp strip. Thoracic part with self adhesive slit 100 cm	300/200 x 300	1	558993
Velcro strips	2/2.5 x 50	2	592550

Only available as a non-sterile pack component

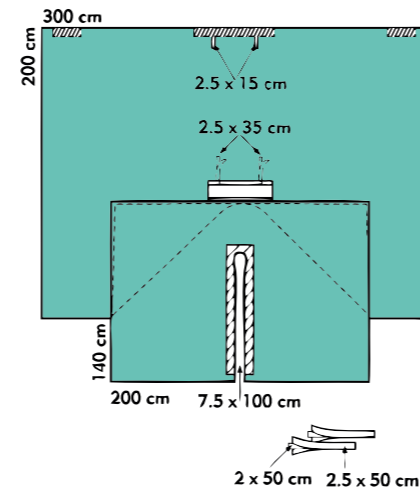

## Bypass Packs

### Cardiovascular/Bypass Pack

**561559**

PU: 3 packs

Cont. and sequence	Size/cm	Qty.	Ref. no.
Plain drape – table cover (wrap)	150 x 200	1	808869
Mayo stand cover	80 x 145	1	547714
Hand towels	20 x 25	4	-/-
Foot covers, 2-ply	32 x 42	2	589950
Diathermy pouch	33 x 28	1	583330
OR tape, elastic	10 x 50	2	591151
Bottom drape, Mediwell	150 x 180	1	501518
Varicose vein drape, U=7.5 x 100 cm	200 x 260	1	528806
Cardiovascular drape	300/225 x 300	1	558914

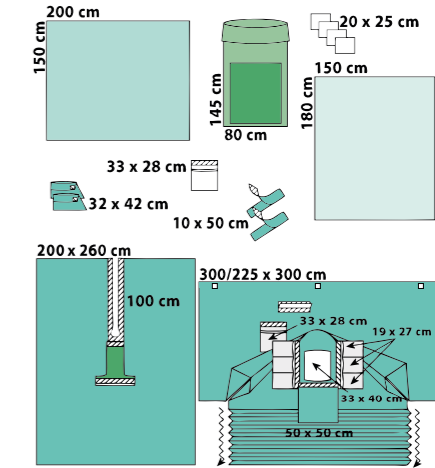

### Bypass Pack 808821 replaced by 808869

**561568**

PU: 6 packs

Cont. and sequence	Size/cm	Qty.	Ref. no.
Plain drape – table cover (wrap)	150 x 200	1	808821
Mayo stand cover	80 x 145	1	547714
Hand towels	20 x 25	4	-/-
Foot covers, 2-ply	32 x 42	2	589950
Diathermy pouch	33 x 28	1	583330
OR tape, elastic	10 x 50	2	591151
Bottom drape, Mediwell	150 x 180	1	501518
Varicose vein drape, U=7.5 x 100 cm	200 x 260	1	528806
Cardiovascular drape	300/225 x 300	1	558998

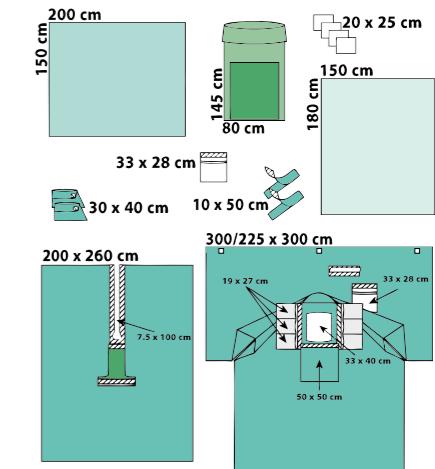

### ~~Bypass Pack~~

delete **561575**

PU: 2 packs

Cont. and sequence	Size/cm	Qty.	Ref. no.
Steriflex overwrap	120 x 120	1	901212
Plain drape – table cover (wrap)	150 x 200	1	808869
OR gown, reinforced	XL = 150	4	464417
Mayo stand cover	80 x 145	2	547714
Mayo stand cover	80 x 145	1	547716
Varicose vein drape, U=7.5 x 100 cm	200 x 260	1	528806
Foot covers, 2-ply	53 x 106	2	588813
OR tape	11 x 50	2	591150
Adhesive drapes, 2-ply	75 x 90	2	538823
Cardiovascular drape	300/225 x 350	1	559000
Diathermy pouches	33 x 28	2	583330
Plain drape, 2-ply	75 x 90	1	508824

Particularity: with additional overwrap, extra standard and reinforced Mayo stand covers

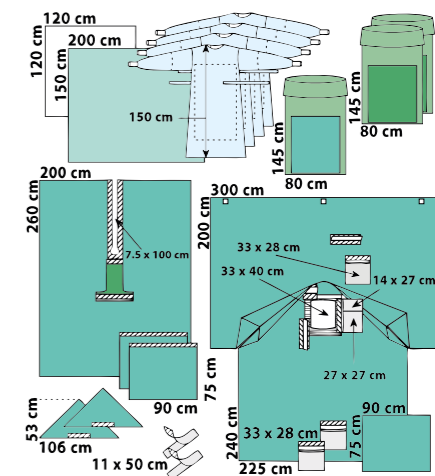

You will find further products in our separate cardio-surgery and angiography brochure.

## Hybrid Drapes

### Cardio/Angiography Drape **559060-9** with thoracic and 2 femoral apertures

Description	Size/cm
with 3 integral, transparent wide film strips, 2 x 100 x 400 cm and 1 x 100 x 300 cm, 2 apertures 12 x 20 cm, 1 aperture 35 x 65 cm with incision film, adhesive, reinforcement 75 x 120 cm, 4 velcro strips and 2 diathermy pouches	300 x 500

Only available as a non-sterile pack component

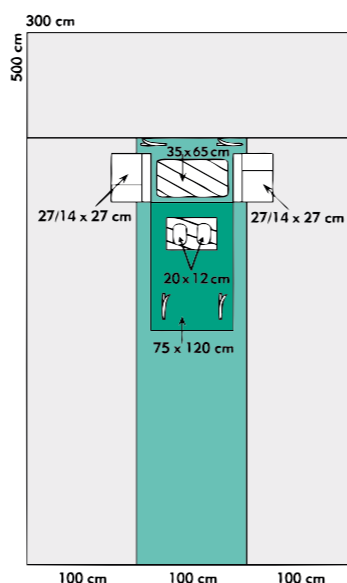

### Cardio/Angiography Drape **559081-9**

Description	Size/cm
with 3 integral, transparent wide film strips, 2 x 100 x 400 cm and 1 x 100 x 300 cm, aperture 44 x 90 cm with incision film, adhesive, reinforcement 75 x 280 cm, 2 velcro strips	300 x 500

Only available as a non-sterile pack component

Note: also available without lateral slits, article number 559181-9, as a non-sterile pack component

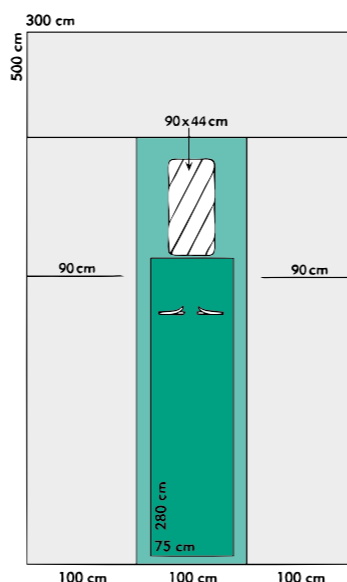

## Supplementary Products

### Varicose Vein Drape **528806**

PU: 16 drapes

Description	Size/cm
100 cm U-slit, adhesive and adhesive perineal drape made of Colordrape, with elastified sides	200 x 260

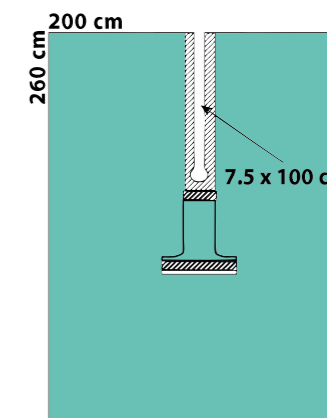

### Foot Covers **589950**

Dispenser, PU: 180 pairs

Description	Size/cm	Qty./disp.
Foot cover with adhesive zone to fix	23-32 x 42	30 pairs

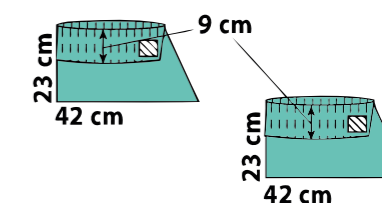

### Foot Covers **589951**

Dispenser, PU: 150 pairs

Description	Size/cm	Qty./disp.
Foot cover made of transparent film drape with adhesive zone to fix	25-34 x 45	50 pairs

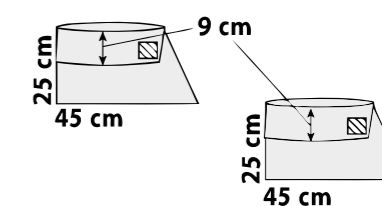

### Pacemaker Drape **559054-9**

Description	Size/cm
Angiography drape with 2 integral, transparent film strips, aperture 12 x 12 cm, adhesive with fenestrated incision film 10 x 10 cm and Mediwell absorb reinforcement	240 x 320

Only available as a non-sterile pack component

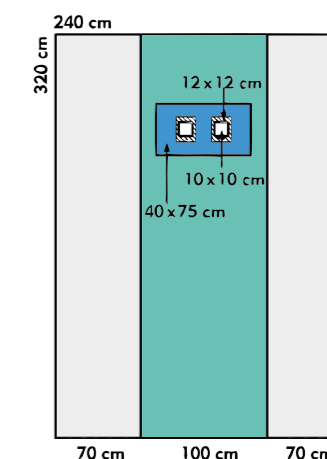

## Angiography Drapes

### Angiography Drape

**558805**

PU: 10 drapes

Description	Size/cm	Qty.	Ref. no.
Transparent film strip 70 cm, 2 apertures 6 x 8 cm, adhesive and absorbent reinforcement 75 x 100 cm	220 x 300	1	558805
OR tape strips	10 x 25	1	591025
Hand towel	20 x 25	1	-/-

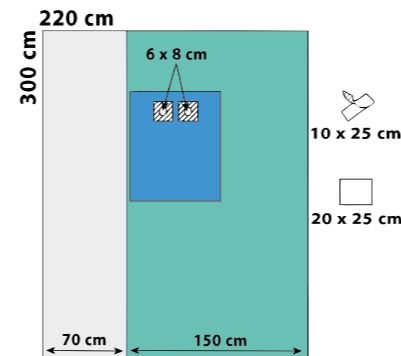

### Angiography Drape

**558956**

PU: 14 drapes

Description	Size/cm	Ref. no.
Angiography drape with 2 integral, transparent wide film strips, 50 cm, 2 apertures 6 x 8 cm, adhesive and absorbent non-woven reinforcement 75 x 100 cm	250 x 320	558956

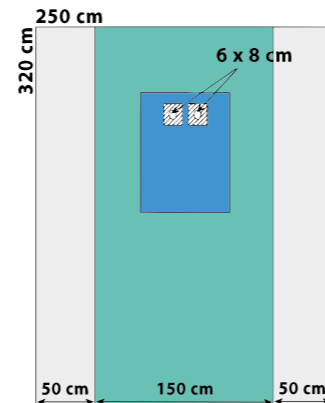

### Angiography Drape, aquamarine **858805** delete

PU: 22 drapes

Description	Size/cm	Qty.	Ref. no.
Angiography drape with trans- parent film side strip 70 cm, 2 apertures 6 x 8 cm, adhesive and absorbent reinforcement 75 x 100 cm	220 x 300	1	858805
OR tape strips	10 x 25	1	591025
Hand towel	20 x 25	1	-/-

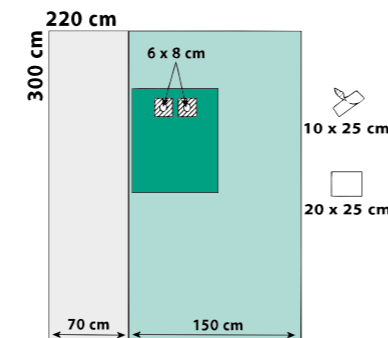

### Angiography Drape

**558918-9**

Description	Size/cm
Angiography drape with transparent film strip 70 cm, 2 apertures 6 x 8 cm, adhesive and absorbent reinforcement 75 x 100 cm	220 x 340

Only available as a non-sterile pack component

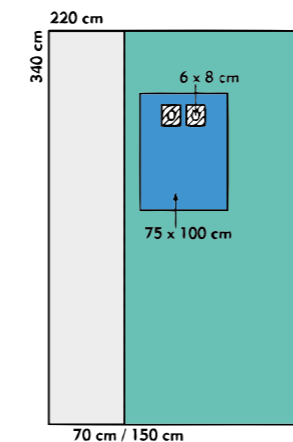

### Angiography Drape

**559053-9**

Description	Size/cm
Angiography drape with 2 transparent film strips 70 cm, 2 apertures Ø 10 cm, adhesive with fenestrated incision film Ø 8 cm and absorbent reinforcement 75 x 100 cm	290 x 380

Only available as a non-sterile pack component

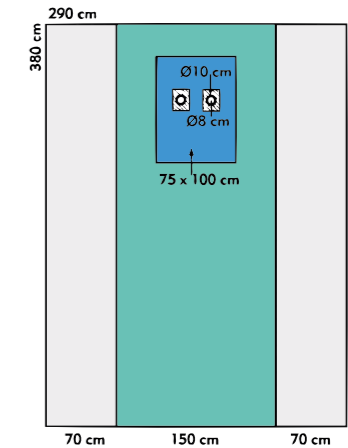

### Angiography Drape

**559071-9**

Description	Size/cm
Angiography drape with 2 transparent film strips 70 cm, 2 apertures 8 x 6 cm, adhesive and absorbent reinforcement 75 x 100 cm	215 x 340

Only available as a non-sterile pack component

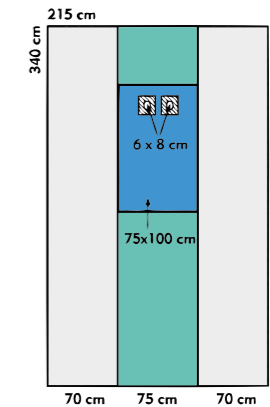

### Angiography Drape

**559059-9**

Description	Size/cm
Angiography drape with 3 transparent film strips 70 cm, 2 apertures 8 x 10 cm, adhesive and absorbent reinforcement 75 x 100 cm	240 x 310

Only available as a non-sterile pack component

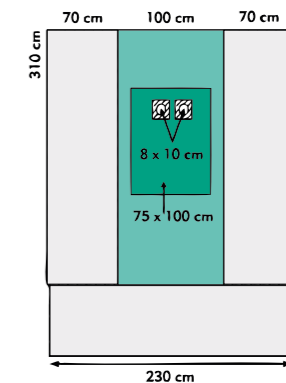

### 4 Femoral Radial Angiography Drape

**559100-9**

Description	Size/cm
Angiography drape with 2 transparent film strips 70 x 240 cm, 2 apertures Ø 12 cm (femoral), adhesive, and 2 apertures Ø 10 cm (radial) with 7 cm fenestrated incision film, adhesive, and absorbent reinforcement	280 x 390

Only available as a non-sterile pack component

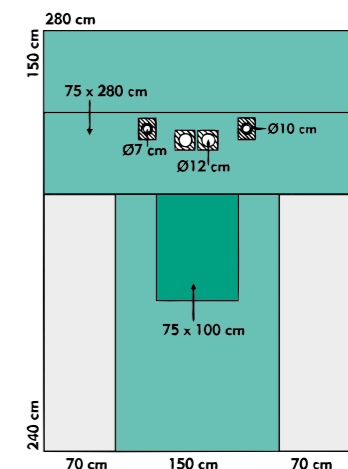

# Orthopaedics, Traumatology



Our products offer highest quality for orthopaedics and traumatological surgeries e.g. joint replacement. Easy handling guarantees high application comfort.

Furthermore, a large selection of extremity drapes with and without pouch are available in a wide range of models.



## Split Sheet Pack

### Split Sheet Pack, standard

**561112**

PU: 7 packs

Cont. and sequence	Size/cm	Qty.	Ref. no.
Plain drape – table cover (wrap)	150 x 200	1	808869
Mayo stand cover	80 x 145	1	547714
Hand towels	25 x 20	4	-/-
Bottom drape, Mediwell 3-ply	150 x 180	1	501518
Split sheet, U=7.5 x 100 cm	200 x 260	1	528805
Adhesive drape	150 x 240	1	538807

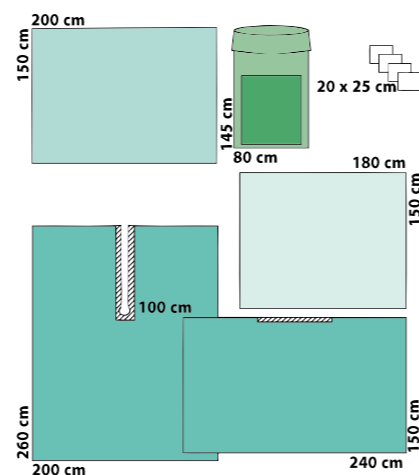

S-Special production, page 29 too

### Split Sheet Pack, Super

**564371**

PU: 8 packs

Cont. and sequence	Size/cm	Qty.	Ref. no.
Plain drape – table cover (wrap)	150 x 200	1	808869
Mayo stand cover	80 x 145	1	547714
Bottom drape, Mediwell 3-ply	150 x 180	1	501518
Split sheet, U=7,5 x 100 cm	225 x 320	1	528808
Adhesive drape	175 x 300	1	538808
Hand towels	25 x 20	2	-/-

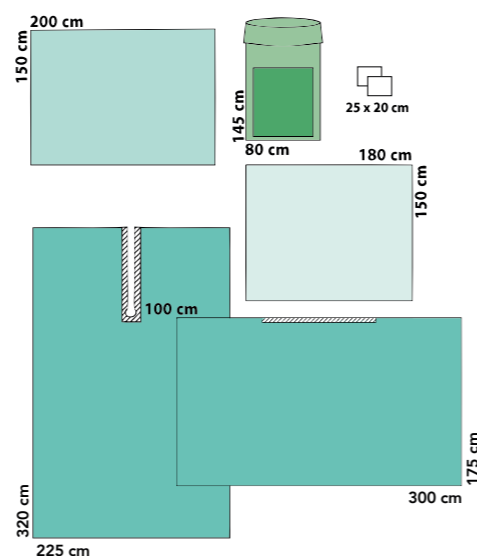

## Extremity Drapes

### Extremity Drape

**518810**

PU: 12 drapes

Description	Size/cm
Extremity drape with Ø 7 cm elastic aperture with cable/tube holder	225 x 320

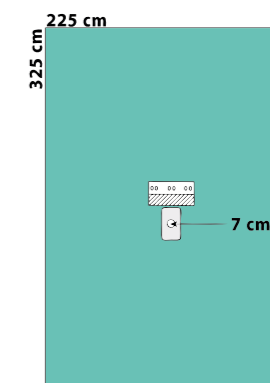

only non-sterile for packs

### Extremity Drape

**518864 -9**

PU: 12 drapes

Description	Size/cm
Extremity drape with Ø 7 cm elastic aperture	245 x 325

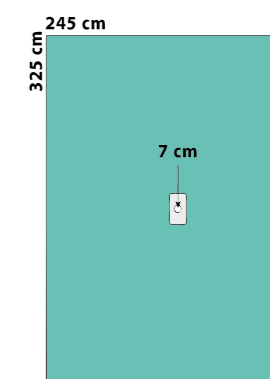

### Extremity Drape

**518820**

PU: 16 drapes

Description	Size/cm
Extremity drape, 2-ply, with Ø 7 cm elastic aperture	200 x 300

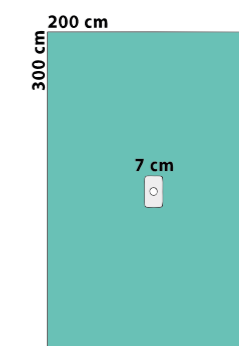

Hier Text eingeben

### Extremity Drape T-Form

**518861-9**

Description	Size/cm
Extremity drape in T-form with 7 cm elastic aperture	280/225 x 450

Only available as a non-sterile pack component

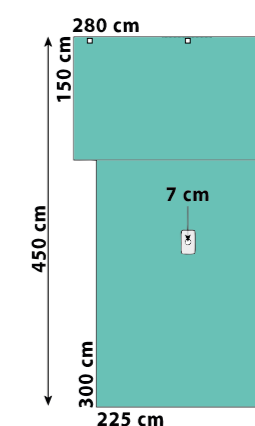

## Extremity Packs

### Extremity Pack, standard **561107**

PU: 8 packs

Cont. and sequence	Size/cm	Qty.	Ref. no.
Plain drape – table cover (wrap)	150 x 200	1	808869
Mayo stand cover	80 x 145	1	547714
Hand towels	25 x 20	4	-/-
Bottom drape	100 x 150	1	508803
Adhesive drape	75 x 75	1	538801
OR tape	10 x 50	2	591050
Extremity drape with Ø 7 cm elastic aperture, cable/tube holder	225 x 325	1	518810

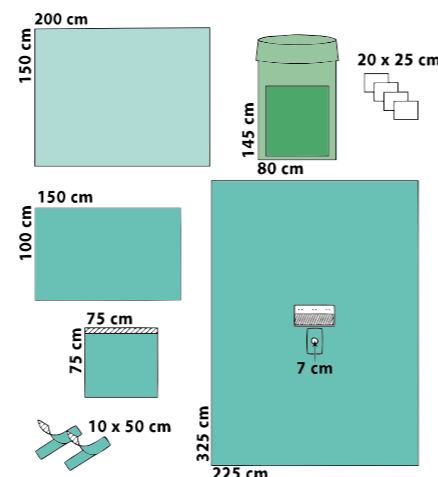

### Extremity Pack, standard 2 **561117**

PU: 7 packs

Cont. and sequence	Size/cm	Qty.	Ref. no.
Plain drape – table cover (wrap)	150 x 200	1	808869
Mayo stand cover	80 x 145	1	547714
Hand towels	25 x 20	4	-/-
Bottom drape, 2-ply	150 x 180	1	508821
Stockinette	33 x 73	1	583355
OR tape, film	11 x 50	2	591150
Extremity drape with Ø 7 cm elastic aperture, cable/tube holder	225 x 325	1	518810

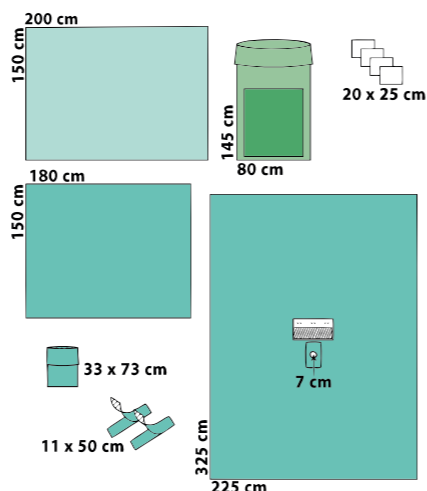

Particularity: with Stockinette

S- special production

### Extremity Pack with Drape T-Form **564349**

PU: 10 packs

Cont. and sequence	Size/cm	Qty.	Ref. no.
Plain drape – table cover (wrap)	150 x 200	1	808869
Mayo stand cover super	80 x 145	1	547718
Bottom drape, 2-ply	150 x 180	1	508821
Stockinette	33 x 73	1	583355
Hand towels	30 x 40	2	624040
OR tape, elastic	10 x 50	2	591151
Velcro strip	2/2.5 x 24	1	592525
Extremity drape in T-form with 7 cm elastic aperture	280/225 x 450	1	518861

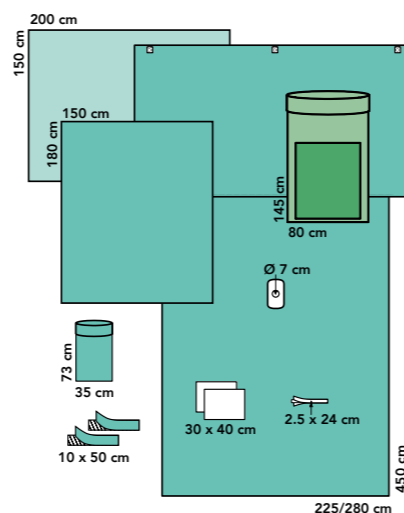

## Arthroscopy Drapes

### Arthroscopy Drape **518813**

PU: 12 drapes

Description	Size/cm
Arthroscopy drape with cable/tube holder and fluid collection pouch with drainage port	225 x 325

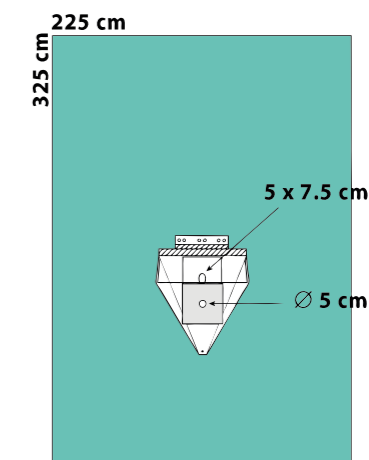

### Arthroscopy Drape "small" **518853**

PU: 24 drapes

Description	Size/cm
Arthroscopy drape "small", 2-ply, with cable/tube holder and fluid collection pouch with drainage port	200 x 300

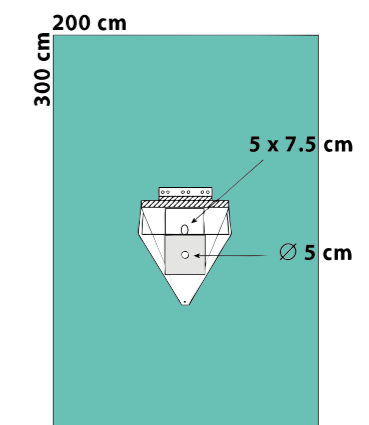

## Arthroscopy Packs

### Arthroscopy Pack, standard 1 561105

PU: 9 packs

Cont. and sequence	Size/cm	Qty.	Ref. no.
Plain drape – table cover (wrap)	150 x 200	1	808869
Mayo stand cover	80 x 145	1	547714
Hand towels	20 x 25	4	-/-
Stockinette, 2-ply	33 x 73	1	583355
OR tape, film	11 x 50	2	591150
Extremity drape with Ø 7 cm elastic aperture, cable/tube holder	225 x 325	1	518810

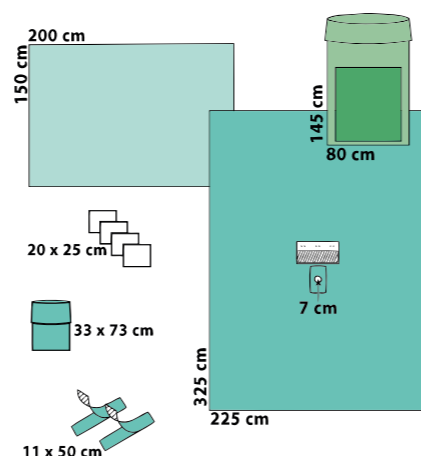

### Arthroscopy Pack with fluid collection pouch 561149

PU: 8 packs

Description	Size/cm	Qty.	Ref. no.
Plain drape – table cover (wrap)	150 x 200	1	808869
Mayo stand cover	80 x 145	1	547714
Plain drape, 2-ply	150 x 180	1	508821
Stockinette	33 x 73	1	583355
OR tape, film	11 x 50	4	591150
Camera tube cover, telescopically	13 x 250	1	581323
Arthroscopy drape with cable/tube holder and fluid collection pouch with drainage port	225 x 325	1	518813

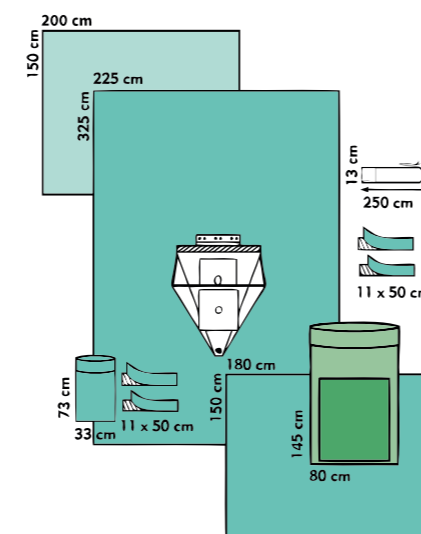

### Arthroscopy Pack, standard 3 563035

PU: 6 packs

Cont. and sequence	Size/cm	Qty.	Ref. no.
Plain drape – table cover (wrap)	150 x 200	1	808869
Hand towels	30 x 40	2	-/-
OR gown, standard	XL = 150	1	464416
OR gown, reinforced	XL = 150	1	464417
Mayo stand cover	80 x 145	1	547714
Stockinette, 2-ply	33 x 73	1	583355
OR tape, film	11 x 50	2	591150
Camera tube cover, telescopically	13 x 250	1	581323
Extremity drape, 2-ply, with Ø 7 cm elastic aperture, decentral and integral velcro strip	200 x 300	1	518819

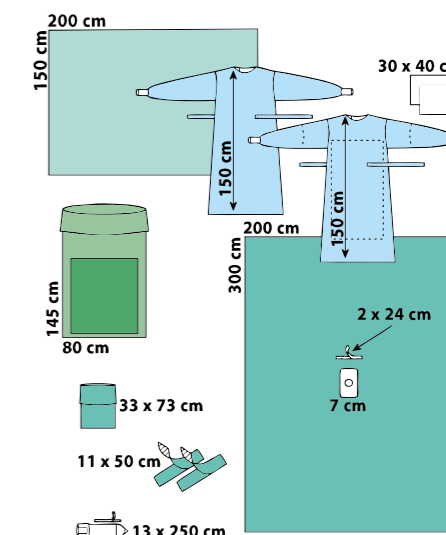

### Arthroscopy Pack with OR gowns 561122

PU: 12 packs

Cont. and sequence	Size/cm	Qty.	Ref. no.
Plain drape – table cover (wrap)	150 x 200	1	808869
Mayo stand cover	80 x 145	1	547714
OR gown, SMS reinforced	XL=150	2	464437
Stockinette	33 x 73	1	583355
OR tape, film	11 x 50	2	591150
Camera tube cover, telescopically	13 x 250	1	581323
Velcro strip	2/2.5 x 25	1	592525
Hand towels	20 x 25	2	-/-
Extremity drape, with Ø 7 cm elastic aperture	200 x 300	1	518820

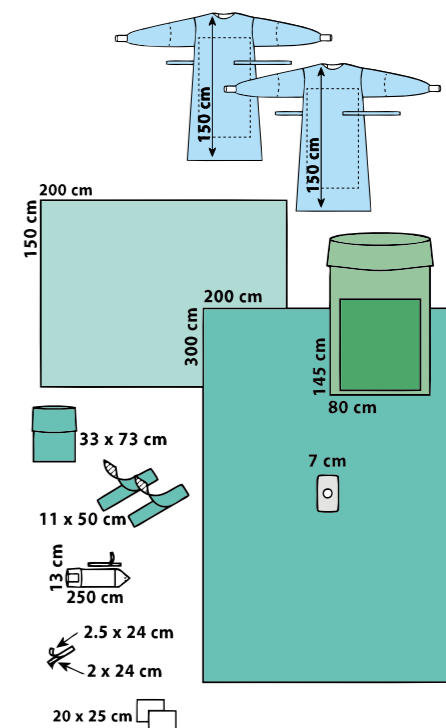

## Shoulder Drape

### Shoulder Drape "Beach Chair" 518835

with integral fluid collection pouch  
PU: 10 drapes

Description	Size/cm
Shoulder drape, pearshaped, 11.5 x 12.5 cm elastic aperture, central, with 5.5 x 20 cm adhesive zone to fix to the patient side; fluid collection pouch with drainage port and pliable rim strip and 3 integral velcro strips on the front. For procedures in the seated position.	380 x 225

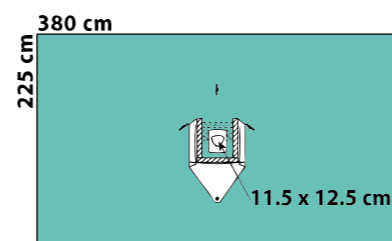

### Shoulder Pack "Beach Chair" 864351

aquamarine  
PU: 14 packs

Cont. and sequence	Size/cm	Qty.	Ref. no.
Plain drape – table cover (wrap)	150 x 200	1	808869
Mayo stand cover	80 x 145	1	547714
Stockinette	17 x 75	1	588827
OR tape, elastic	10 x 50	2	591151

Shoulder drape, aquamarine, pearshaped, 11.5 x 12.5 cm elastic aperture, central, with 5.5 x 20 cm adhesive zone to fix to the patient side; fluid collection pouch with drainage port and pliable rim strip 3 integral velcro strips on the front. For procedures in the seated position.	380 x 225	1	818835
--	-----------	---	--------

S- special production

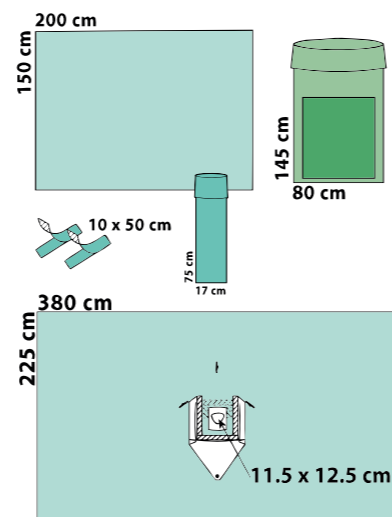

### Shoulder Split Sheet Pack delete 861112

aquamarine  
PU: 7 packs

Cont. and sequence	Size/cm	Qty.	Ref. no.
Plain drape – table cover (wrap)	150 x 200	1	808869
Mayo stand cover	80 x 145	1	547714
Stockinette	33 x 73	1	883355
OR tape, elastic	10 x 50	2	591151
Abdecktuch	150 x 180	1	808821
Split sheet, U= 7,5 x 100 cm	225 x 320	1	828805
Adhesive drape	150 x 240	1	838807
Hand towels	20 x 25	2	-/-

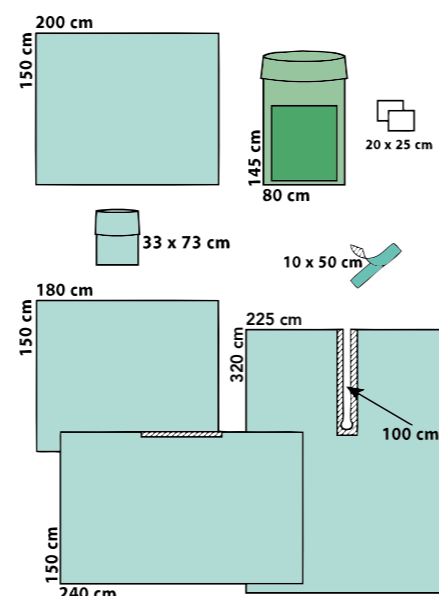

## Hand Surgery Drapes

### Hand Surgery Drape 518844

PU: 20 drapes

Description	Size/cm
Hand surgery drape, 2-ply, T-form, with integral arm table cover and elastic aperture Ø 3 cm	360/150 x 330

### Hand Surgery Pack 563903

PU: 14 packs

Cont. and sequence	Size/cm	Qty.	Ref. no.
Plain drape – table cover (wrap)	150 x 200	1	808869
Mayo stand cover	80 x 145	1	547718
Hand surgery drape, 2-ply, T-form, with integral arm table cover and elastic aperture Ø 3 cm	360/160 x 330	1	518844

### Hand Surgery Drape 518845

PU: 20 drapes

Description	Size/cm
Hand surgery drape, 2-ply, T-form, with integral arm table cover and elastic aperture Ø 3 cm	360/160 x 280

### Hand Surgery Drape, aquamarine 818848-9

Description	Size/cm
Hand surgery drape, 2-ply, T-form, with integral arm table cover with elastic aperture Ø 3 cm and absorbent non-woven reinforcement	360/150 x 295

Only available as a non-sterile pack component

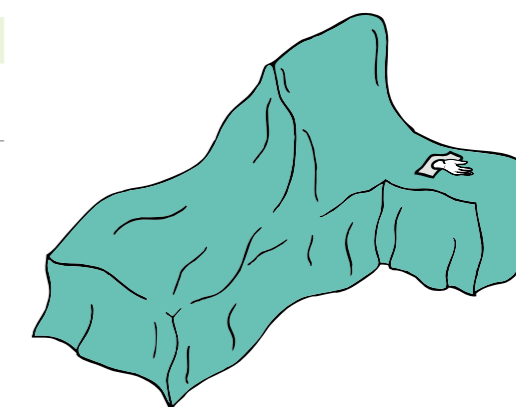

not in the print catalogue

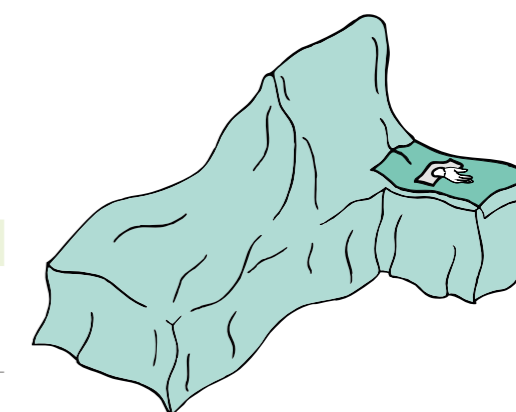
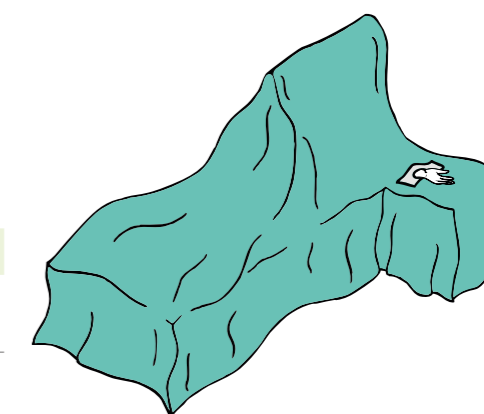



## Hand/Foot Pack and Drapes

### Hand/Foot Pack **564185**

PU: 10 packs

Cont. and sequence	Size/cm	Qty.	Ref. no.
Plain drape – table cover (wrap)	150 x 200	1	808869
Mayo stand cover	80 x 145	1	547714
Hand/Foot drape	225 x 300	1	518815

Particularity: with larger back table cover

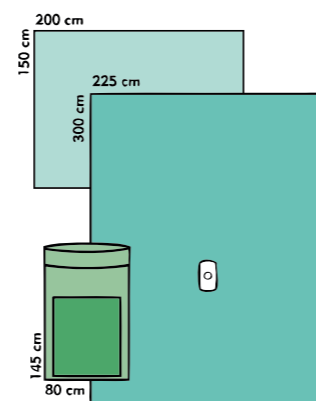

### Hand/Foot Drape **518815**

PU: 12 drapes

Description	Size/cm
Extremity drape with Ø 3 cm elastic aperture, decentral	225 x 300

### ~~Hand/Foot Drape, aquamarine~~ **818815-9** delete

Description	Size/cm
Extremity drape with Ø 3 cm elastic aperture, decentral	225 x 300

Only available as a non-sterile pack component

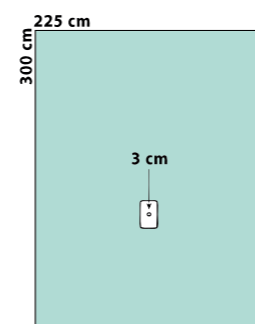

### Extremity Drape "small" **518825**

Dispenser, PU: 45 drapes

Description	Size/cm	Qty./disp.
Extremity drape, 2-ply, with Ø 4 cm elastic aperture	100 x 160	15

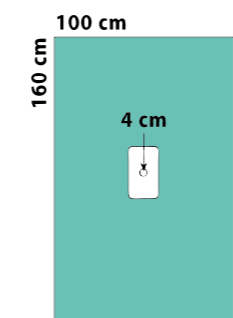

### Dual Extremity Drape **518832-9**

for procedures on both feet

Description	Size/cm
Dual extremity drape, 2-ply, with Ø 4 cm elastic apertures, decentral	225 x 320

Only available as a non-sterile pack component

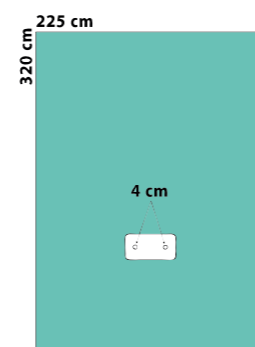

## Hip Pack and Drape

### Hip Pack, standard **561110**

PU: 5 packs

Cont. and sequence	Size/cm	Qty.	Ref. no.
Plain drape – table cover (wrap)	150 x 180	1	808821
Mayo stand cover	80 x 145	1	547714
Hand towels	20 x 25	4	-/-
Plain drape, 2-ply	75 x 90	1	508824
Plain drape	150 x 180	1	508801
Stockinette, 2-ply	35 x 120	1	583311
OR tape, film	11 x 50	2	591150
Split sheet, U=7.5 x 100 cm	200 x 260	1	528805
Adhesive drape	175 x 300	1	538808

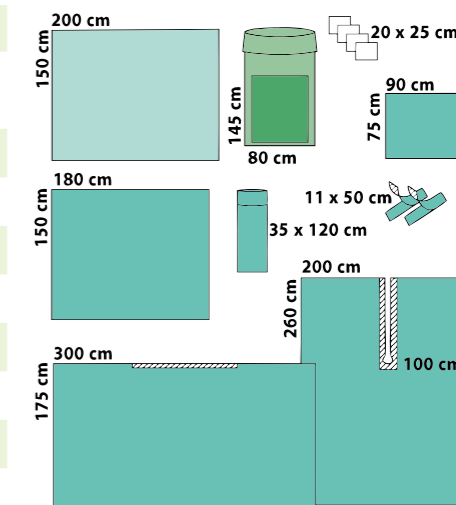

### Hip Drape T-Form **518890-9**

Description	Size/cm
Hip drape T-form, with Ø 20 cm elastic aperture with adhesive zone and 2 integral pouches 80 x 100 cm	280/225 x 390

Only available as a non-sterile pack component

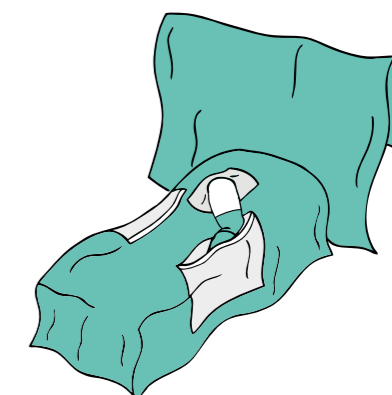

### Hip Pack, Super S- special production **564174**

PU: 5 packs

Cont. and sequence	Size/cm	Qty.	Ref. no.
Plain drape – table cover (wrap)	150 x 200	1	808869
Mayo stand cover super	80 x 145	1	547718
Hand towels	20 x 25	4	-/-
Plain drape, 2-ply	75 x 90	1	508824
Plain drape	150 x 180	1	508801
Stockinette, 2-ply	35 x 120	1	583311
OR tapr, elastic	11 x 50	2	591151
Split sheet, U = 7,5 x 100 cm	225 x 320	1	528808
Adhesive drape	175 x 300	1	538808
Velcro strip	2/2.5 x 25	1	592525

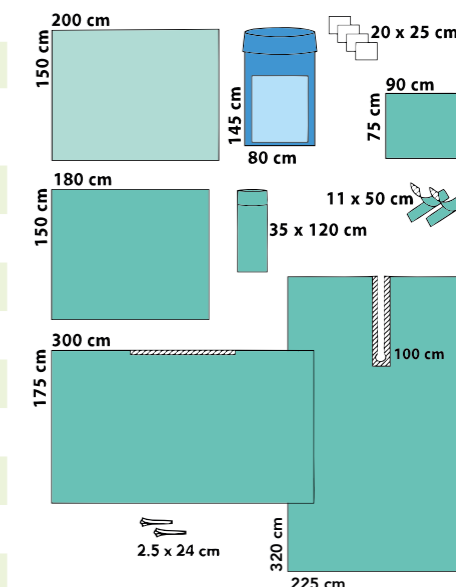

## Vertical Isolation Drapes and Packs

### Vertical Isolation Drape Pack 1 **563696**

PU: 20 packs

Cont. and sequence	Size/cm	Qty.	Ref. no.
Plain drape – table cover (wrap)	150 x 200	1	808869
Mayo stand cover	80 x 145	1	547714
Hand towels	25 x 20	4	-/-
Vertical isolation drape	330 x 244	1	556610

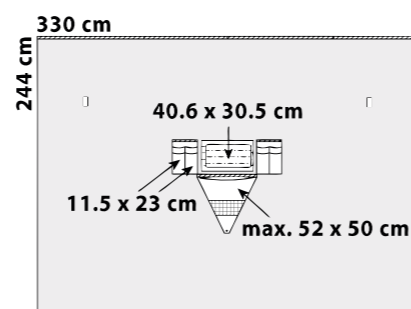
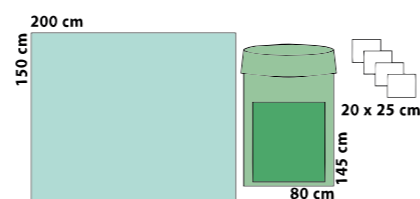

### Vertical Isolation Drape **556610**

PU: 10 drapes

Description	Size/cm
Vertical isolation drape with 40.6 x 30.5 cm aperture with integral incision film; 2 diathermy pouches and velcro strips; fluid collection pouch with sieve and drainage port; 1.3 x 330 cm adhesive zone	330 x 244

### Vertical Isolation Drape Pack 2 **563675**

PU: 7 packs

Cont. and sequence	Size/cm	Qty.	Ref. no.
Plain drape – table cover (wrap)	150 x 200	1	808869
Mayo stand cover	80 x 145	1	547714
Hand towels	25 x 20	4	-/-
Vertical isolation drape	330 x 244	1	556611

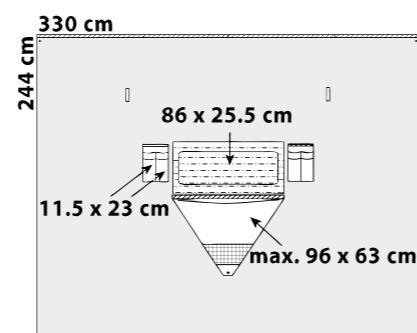
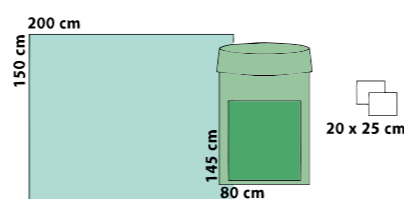

### Vertical Isolation Drape **556611**

PU: 18 drapes

Description	Size/cm
Vertical isolation drape with 86.4 x 25.4 cm aperture with integral incision film; 2 diathermy pouches and velcro strips; fluid collection pouch with sieve and drainage port; 1.3 x 330 cm adhesive zone	330 x 244

## Supplementary Products

### Velcro Strip **592525**

Dispenser, PU: 600 pcs.

Description	Size/cm	Qty./disp.	Ref. no.
OP-velcro strip	2/2.5 x 24	100	592525



### Camera Tube Covers dispenser

Description	Size/cm	Qty./disp.	Ref. no.
Camera tube cover, reverse PU: 210 covers	13 x 250	35	581322
Camera tube cover, telescopically PU: 192 covers	13 x 250	32	581323
Camera tube cover, telescopically PU: 192 covers	13 x 250	32	581324
Camera tube cover, telescopically PU: 150 covers	13 x 250	25	581325
Camera tube cover, telescopically PU: 90 covers	18 x 250	30	581825

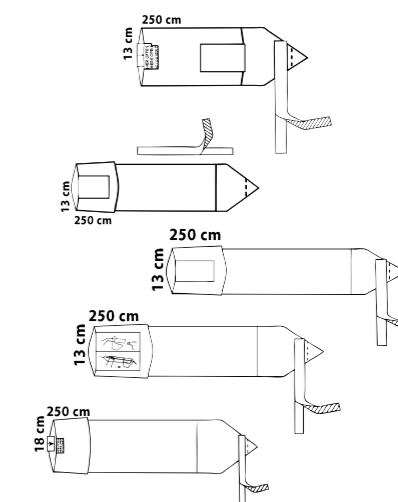

### Fluid Collection Pouches

Dispenser, PU: 75 pouches

Description	Size/cm	Qty./disp.	Ref. no.
For hip procedures	64 x 100	25	588010

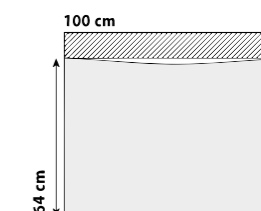

### Fluid Collection Pouches for Arthroscopies

Dispenser, PU: 50 pouches

Description	Size/cm	Qty./disp.	Ref. no.
Shoulder, with U = 7.5 x 46 cm adhesive and 2 drainage ports	59/80 x 76	25	589978

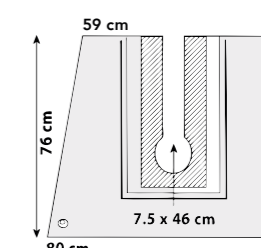

## Supplementary Products

### Elastic Inlets, non-sterile

Description	Size/cm	Qty.	Ref. no.
Aperture Ø 7 cm, central PU: 1.000 pcs.	25 x 40	100	582540-9
Aperture Ø 7 cm, central PU: 500 pcs.	40 x 40	50	584040-9

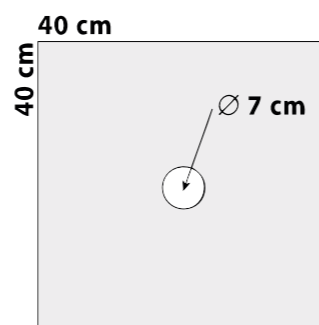

### Image Intensifier Covers

Dispenser, PU: 105 pcs.

Description	Size/cm	Qty./disp.	Ref. no.
with drawstring	75 x 65	35	587565 delete

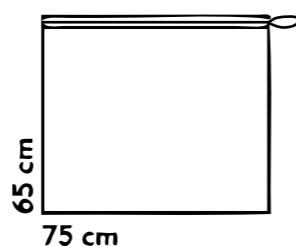

### Image Intensifier Covers and Packs

Description	Qty./disp.	Ref. no.
Pack 1, for Philips equipment, 3-part PU: 54 packs	18	565803
Pack 2, for Siemens equipment, 1-part with 2 tapes PU: 30 packs	10	565804
Pack 3, for Philips BV29 equipment, 3-part PU: 24 packs	24	565805
Pack 4, for Siemens ISO-C, 1-part with 2 OR tapes PU: 50 packs	50	565851
Pack 5, for Siemens equipment, 1-part with 3 OR tapes PU: 30 packs	S- special production 10	565856

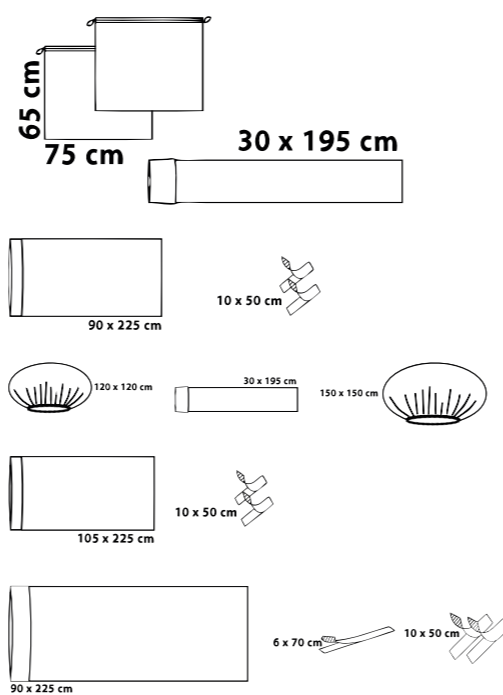

### Stockinettes dispenser

Description	Size/cm	Qty./disp.	Ref. no.
2-ply + 2 film tapes PU: 120 stockinettes	35 x 73	40	583355
2-ply + 2 film tapes PU: 75 stockinettes	35 x 120	25	583311
2-ply + special tapes PU: 180 stockinettes	17 x 75	60	588827
US model PU: 150 stockinettes	23 x 80	25	580001
US model PU: 90 stockinettes	23 x 110	15	580002
US model PU: 51 stockinettes	32 x 120	17	580003

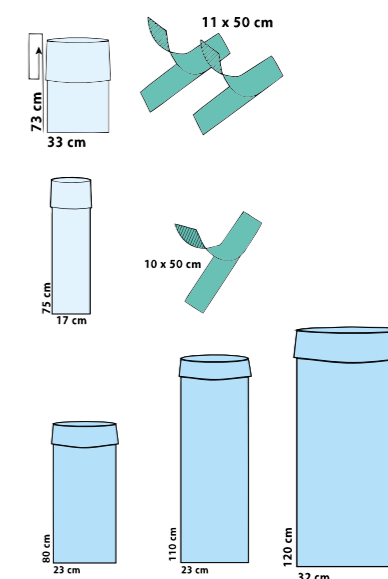

### Stool Covers dispenser

Description	Size/cm	Qty./disp.	Ref. no.
Mediwell super, 2-ply PU: 90 covers	75 x 75	15	588875
Mediwell super, 2-ply elastified PU: 210 covers	60 x 60	35	588860

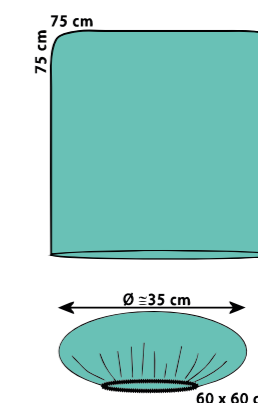

### OR Tapes dispenser

Description	Size/cm	Qty./disp.	Ref. no.
non-woven, standard PU: 780 tapes	10 x 50	130	591050
non-woven, elastic PU: 750 tapes	10 x 50	125	591151
film PU: 660 tapes	11 x 50	110	591150

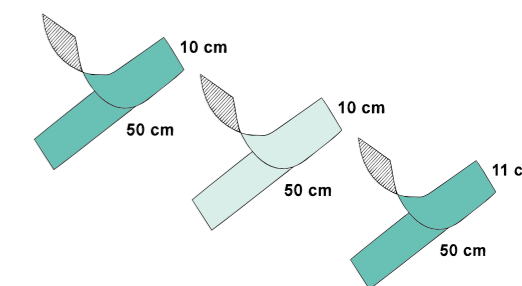

# Urology



Indication adapted solutions for urology.

A wide product range is available in different varieties and material qualities for transurethral interventions up to operations with DaVinci robots or other MIC methods.



## Urology Drapes

### TUR Drape with leggings and sieve 558882

PU: 16 drapes

Description	Size/cm
TUR drape with 6 x 10 cm aperture, adhesive, with sieve, finger cot and Ø 6 cm suprapubic aperture with incision film	225 x 260

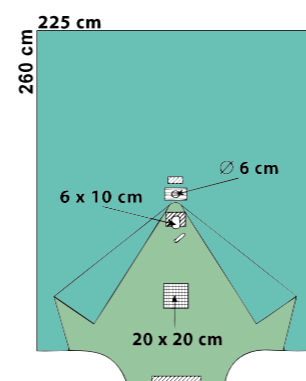

### TUR Drape with leggings and fluid collection pouch 558892

PU: 12 drapes

Description	Size/cm
TUR drape with 6 x 10 cm adhesive aperture; with fluid collection pouch with sieve, finger cot and drainage port; Ø 6 cm suprapubic aperture with incision film	225 x 260

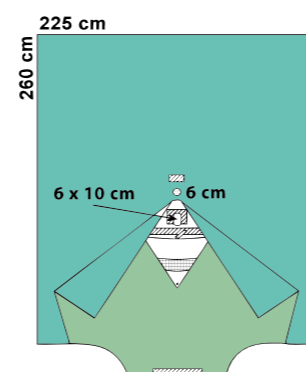

### TUR Drape "small" with leggings and sieve 558862

PU: 30 drapes

Description	Size/cm
TUR drape, 2-ply, with 6 x 10 cm aperture, adhesive, with sieve, finger cot and suprapubic aperture Ø 6 cm with incision film	150 x 200

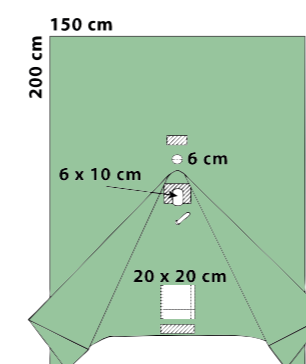

### TUR Drape "small" with leggings and fluid collection pouch 559015-9

Description	Size/cm
TUR drape 2-ply, with Ø 6 cm non-adhesive aperture; with finger cot, large fluid collection pouch with sieve and drainage port, Ø 6 cm suprapubic aperture with incision film	150 x 200

Only available as a non-sterile pack component

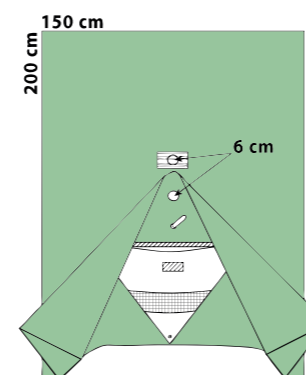

### GYN-TVT Drape with leggings 559050-9

Description	Size/cm
GYN-TVT drape, 12/13 x 32 cm aperture, adhesive, with fluid collection pouches with sieve and drainage port	225 x 260

Only available as a non-sterile pack component

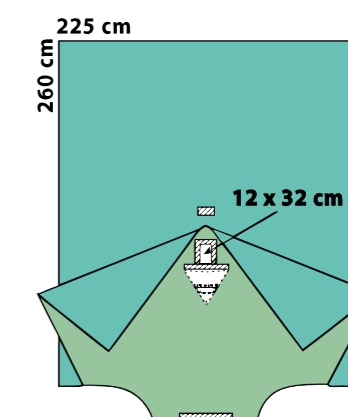

### Universal Urology Drape 559086-9

Description	Size/cm
Urology drape 2-ply, with 6 x 10 cm aperture, adhesive, with finger cot, fluid collection sieve and drainage port, suprapubic aperture 15 x 13 cm with fenestrated incision film	150 x 200

Only available as a non-sterile pack component

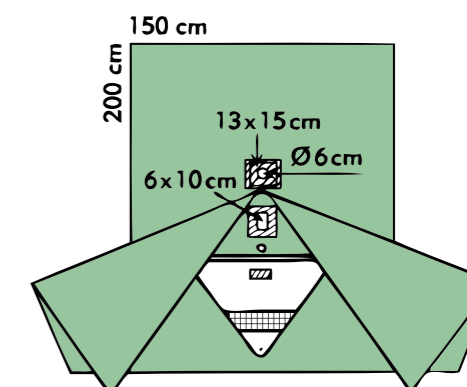

## Urology Packs

### TUR Pack, standard

**561202**

PU: 14 packs

Cont. and sequence	Size/cm	Qty.	Ref. no.
Plain drape – table cover (wrap)	100 x 150	1	808823
Hand towels	20 x 25	4	-/-
TUR drape with 6 x 10 cm adhesive aperture; with sieve, finger cot and Ø 6 cm suprapubic aperture with incision film	225 x 260	1	558882

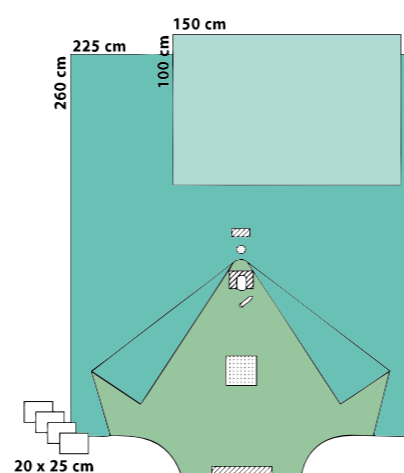

### TUR Pack 2

**564257**

PU: 14 packs

Cont. and sequence	Size/cm	Qty.	Ref. no.
Plain drape – table cover (wrap)	150 x 200	1	808869
Hand towels	20 x 25	2	-/-
OR tape	10 x 50	1	591050
TUR drape with 6 x 10 cm adhesive aperture; with sieve and finger cot	225 x 260	1	559011

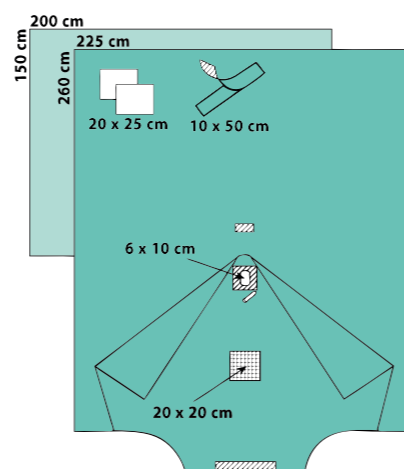

Particularity: with larger back table cover, TUR drape without suprapubic aperture

not in the print catalogue

### TUR Pack with fluid collection pouch

**564226**

PU: 20 packs

Cont. and sequence	Size/cm	Qty.	Ref. no.
Plain drape – table cover (wrap)	100 x 150	1	808823
Hand towels	20 x 25	2	-/-
OR tape	10 x 50	1	591050
TUR drape 2-ply, with Ø 6 cm non-adhesive aperture; with finger cot, large fluid collection pouch with sieve and drainage port, Ø 6 cm suprapubic aperture with incision film	150 x 200	1	559015

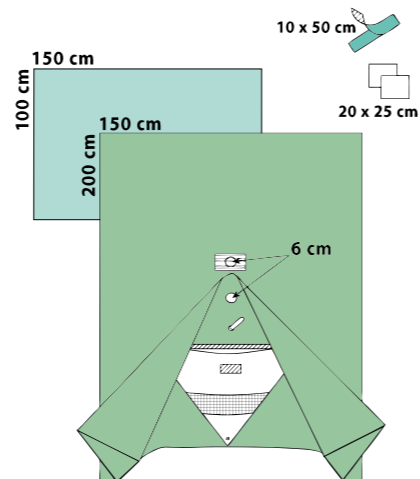

## Split Sheets/DaVinci Drapes

### Split Sheet with leggings

**528876-9**

Description	Size/cm
Split sheet with U-slit 45 x 90 cm, adhesive with leggings	225 x 240

Only available as a non-sterile pack component

In combination with an adhesive drape it is possible to create a variable incision area

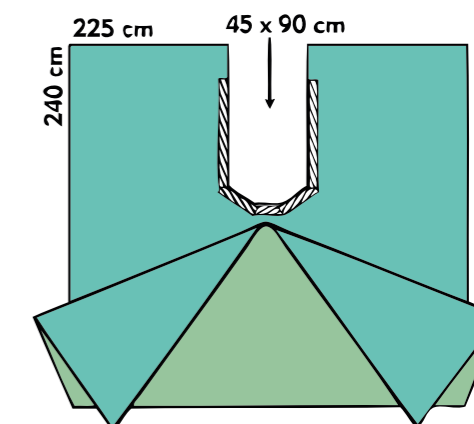

### Split Sheet with rectal aperture and leggings

**528877-9**

Description	Size/cm
Split sheet with U-slit 45 x 90 cm, adhesive with leggings and rectal aperture 14 x 16 cm	225 x 240

Only available as a non-sterile pack component

In combination with an adhesive drape it is possible to create a variable incision area

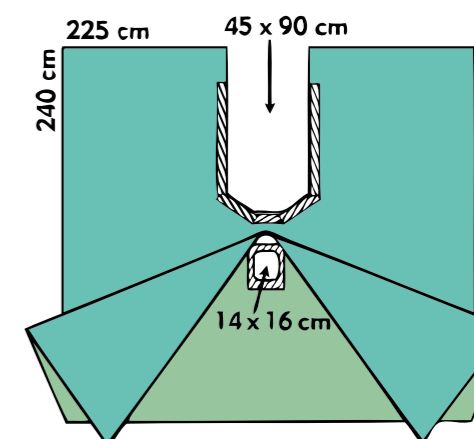

### DaVinci Drapes, T-Form

**558874-9**

Description	Size/cm
T-form, OR aperture 45 x 50 cm, adhesive, with leggings, MIS diathermy pouch 50 x 30 cm, diathermy pouch 60 x 27 cm and 2 velcro strips	300/225 x 495

Only available as a non-sterile pack component

For procedures with DaVinci robot or other MIS methods.

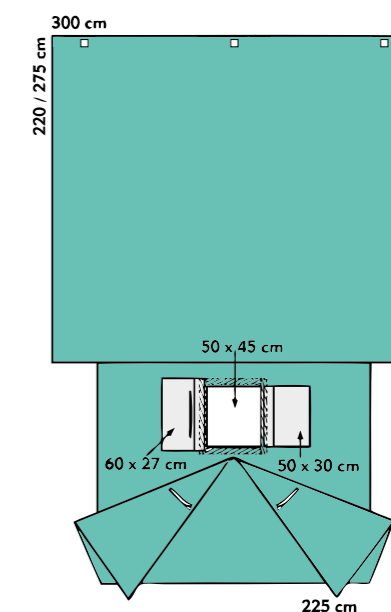

## Small Drapes and Packs

### TUR Drape 518841

Dispenser, PU: 45 drapes

Description	Size/cm	Qty./disp.
TUR drape, 2-ply, $\diamond$ 8 x 11 cm non-adhesive aperture, decentral; with sieve	100 x 230	15

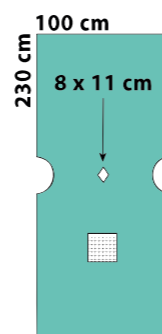

### CYST Drape 518842

Dispenser, PU: 66 drapes

Description	Size/cm	Qty./disp.
CYST drape, 2-ply, $\diamond$ 8 x 11 cm non-adhesive aperture, central	75 x 200	22

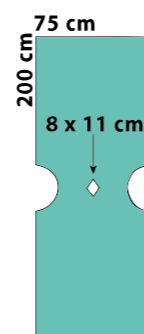

### CYST Pack 561204

PU: 20 packs

Cont. and sequence	Size/cm	Qty.	Ref. no.
Plain drape, 2-ply	75 x 90	1	508824
CYST drape, 2-ply, $\diamond$ 8 x 11 cm aperture	75 x 200	1	518842
Leggings, 2-ply	75 x 120	2	588812

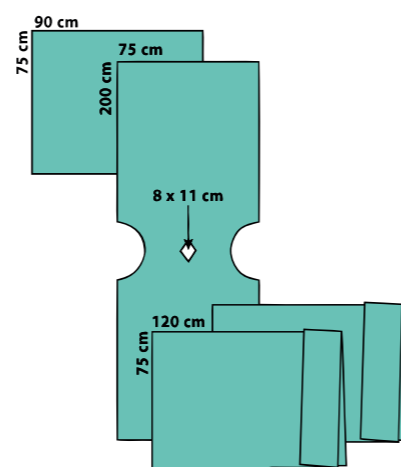

### CYST Pack, aquamarine delete 861204

PU: 20 packs

Cont. and sequence	Size/cm	Qty.	Ref. no.
Plain drape, 2-ply	75 x 90	1	808824
CYST drape, 2-ply, $\diamond$ 8 x 11 cm aperture	75 x 200	1	818842
Leggings, 2-ply	75 x 120	2	888812

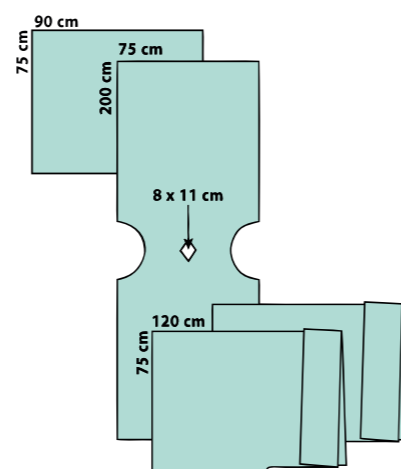

## Supplementary Products

### Rectal Shield 516601

Dispenser, PU: 228 drapes

Description	Size/cm	Qty./disp.
Rectal shield with finger cot and adhesive zones	60 x 90	38

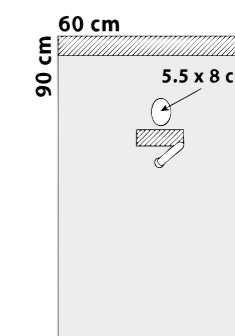

### TUR Gown

Description	Length/cm	PU.	Ref. no.
Non-woven yoke area	L/XL = 140	26	464455
Non-woven yoke area	XL = 150	26	464428

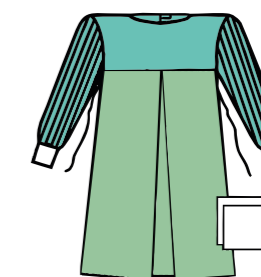

### Leggings dispenser

Description	Length/cm	Qty./disp.	Ref. no.
Mediwell super 2-ply PU: 60 pairs	50 x 110	10 pairs	588811
Mediwell super 2-ply PU: 36 pairs	75 x 120	12 pairs	588812
<del>aquamarine 2-ply PU: 30 pairs</del>	75 x 120	10 pairs	888812 <input type="checkbox"/> delete

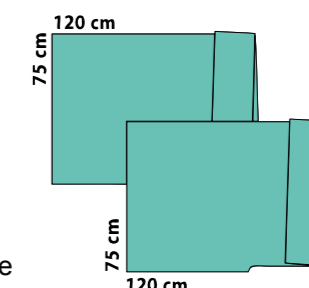

### Fluid Collection Pouch, adhesive 589901

Dispenser, PU 50 pouches

Description	Length/cm	Qty./disp.
with sieve and drainage port	55 x 50	25

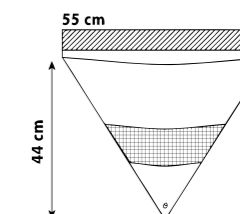

### Split Aperture Drape 520057-9

Description	Length/cm
Split aperture drape Mediwell 2-ply aperture $\varnothing$ 6 cm, central, slit 27 cm	60 x 60

Only available as a non-sterile pack component

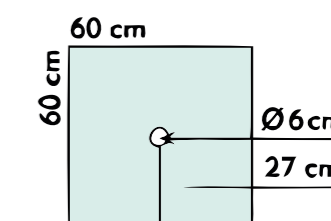

# Gynaecology



For the special requirements in gynaecology our product range includes a selection of drapes and packs for vaginal and abdominal interventions. Our C-section drapes are especially adapted to the anatomy of expectant mothers and are suitable for various positions.

Different drape variations are available for outpatient interventions, as well as for laparoscopically assisted vaginal hysterectomies.





## GYN Drape and Pack

### GYN/TVT Drape with leggings **559050-9**

Description	Size/cm
GYN/TVT drape, 12/13 x 32 cm aperture, adhesive, with fluid collection pouch with sieve and drainage port	225 x 260
Only available as a non-sterile pack component	

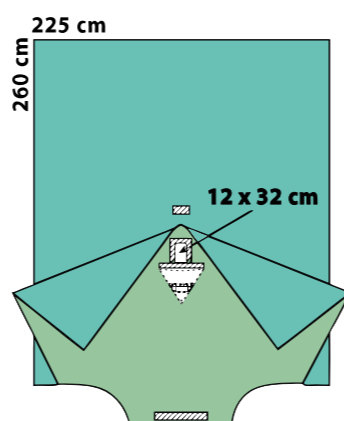

### GYN Pack, standard **561207**

PU: 12 packs

Cont. and sequence	Size/cm	Qty.	Ref. no.
Plain drape – table cover (wrap)	150 x 200	1	808869
Mayo stand cover	80 x 145	1	547714
Hand towels	20 x 25	4	-/-
Adhesive drape, 2-ply	50 x 50	1	538822
GYN drape with leggings, 9 x 17 cm aperture, adhesive	225 x 260	1	558881

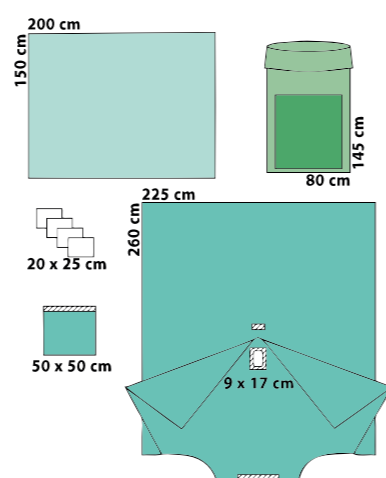

### Leggings dispenser

not in the print catalogue

Description	Length/cm	Qty./disp.	Ref. no.
Mediwell super 2-ply PU: 60 pairs	50 x 110	10 pairs	588811
Mediwell super 2-ply PU: 36 pairs	75 x 120	12 pairs	588812
<del>aquamarine 2-ply PU: 30 pairs</del>	<del>75 x 120</del>	<del>10 pairs</del>	<del>888812</del>

✗ delete

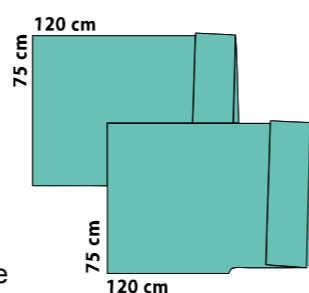

## Pfannenstiel Drape and Pack

### Pfannenstiel Drape **558807**

S- special production

PU: 14 drapes

Description	Size/cm
Pfannenstiel drape, 18 x 29 cm aperture, adhesive	225 x 320

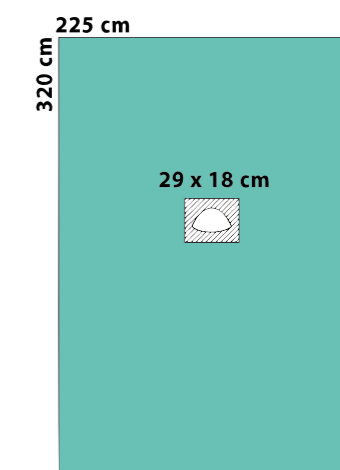

### Pfannenstiel Pack, standard **561208**

PU: 8 packs

Cont. and sequence	Size/cm	Qty.	Ref. no.
Plain drape – table cover (wrap)	150 x 200	1	808869
Mayo stand cover	80 x 145	1	547714
Hand towels	20 x 25	4	-/-
OR tape	10 x 50	1	591050
Pfannenstiel drape with leggings, 18 x 29 cm aperture, adhesive	225 x 320	1	558883

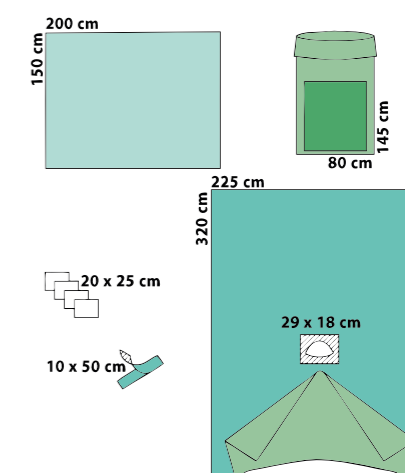

## C-Section Drapes and Pack

### C-Section Drape **558813**

PU: 12 drapes

Description	Size/cm
C-section drape with adhesive 29 x 24 cm aperture; with 360° fluid collection pouch with aperture incision film and drainage port	225 x 320

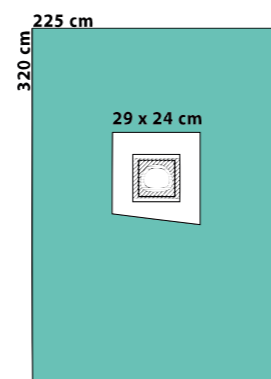

### ~~C-Section Drape T-Form~~ delete **859122-9** aquamarine

Description	Size/cm
T-form, adhesive 37 x 37 cm aperture; with 360° fluid collection pouch with 17.5 x 21 cm aperture incision film and integral cable/tube holder	280/225 x 300

Only available as a non-sterile pack component

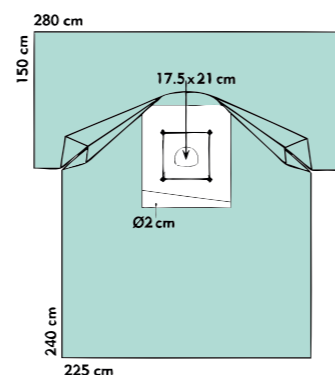

### C-Section Pack, standard **561206**

PU: 7 packs

Cont. and sequence	Size/cm	Qty.	Ref. no.
Plain drape – table cover (wrap)	150 x 200	1	808869
Mayo stand cover	80 x 145	1	547714
Hand towels	20 x 25	4	-/-
Sectio drape with leggings, with 24 x 29 cm aperture, adhesive, with 360° fluid collection pouch with aperture incision film and drainage port	225 x 320	1	558893
Baby sheet, 2-ply	100 x 150	1	508823

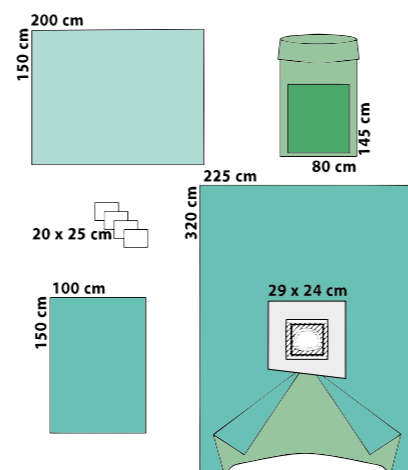

### C-Section Drape with leggings **558893**

PU: 10 drapes

Description	Size/cm
C-section drape with leggings, 29 x 24 cm aperture, adhesive; with 360° fluid collection pouch with aperture incision film and drainage port	225 x 320

### C-Section Drape T-Form **559057-9**

Description	Size/cm
C-section drape in T-form, anaesthesia part with double film thickness, 3 integral adhesive strips to fix; aperture 29 x 30 cm, fluid collection pouch with aperture incision film and drainage port	280/225 x 390

Only available as a non-sterile pack component

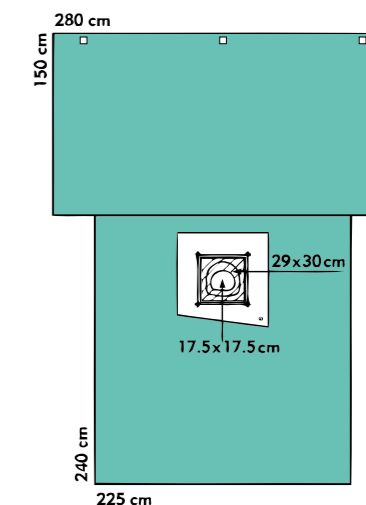

### C-Section Drape **558942-9**

Description	Size/cm
C-section drape with adhesive 29 x 24 cm aperture, with 360° fluid collection pouch incision film and drainage port	225 x 320

Only available as a non-sterile pack component

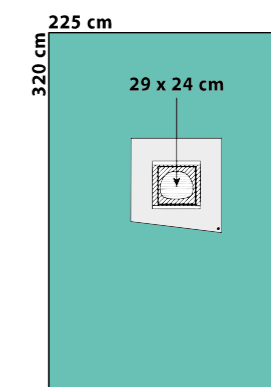

### Baby Sheet Mediwell soft **585764**

Dispenser, PU: 78 drapes

Description	Size/cm	Qty./disp.
Plain drape	100 x 150	26

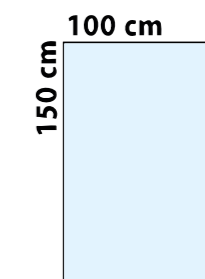

## GYN/LAP Drapes

### GYN/LAP Drape **558887**

PU: 5 drapes

Description	Size/cm
GYN/LAP drape with 29 x 32 cm adhesive aperture; with additional 9 x 17 cm vaginal aperture, adhesive, with protective curtain	225 x 320

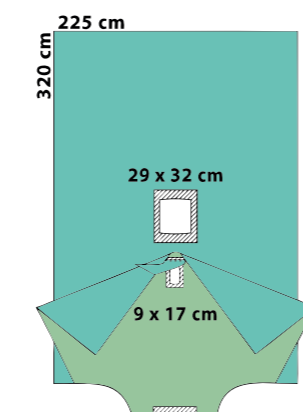

### GYN/LAP Drape T-Form **559062-9**

Description	Size/cm
GYN/LAP-drape T-form, anaesthesia part with double film thickness, 3 integral adhesive strips to fix; aperture 29 x 32 cm, adhesive, with additional vaginal aperture 9 x 17 cm, adhesive, with protective curtain	280/225x 350

Only available as a non-sterile pack component

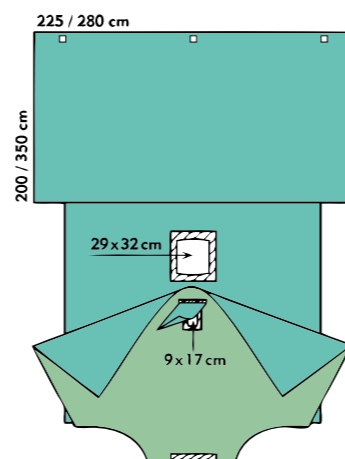

### GYN/LAP Pack not in the print catalogue **561216**

PU: 5 packs

Cont. and sequence	Size/cm	Qty.	Ref. no.
Plain drape – table cover (wrap)	150 x 200	1	808869
Mayo stand cover	80 x 145	1	547714
Hand towels	20 x 25	2	-/-
Velcro strip	2/2.5 x 25	1	592525
GYN/LAP drape (description see above)	225 x 320	1	559062

## Small Drapes

### CYST Drape **518842**

Dispenser, PU: 66 drapes

Description	Size/cm	Qty./disp.
CYST drape, 2-ply, $\diamond$ 8 x 11 cm aperture, central	75 x 200	22

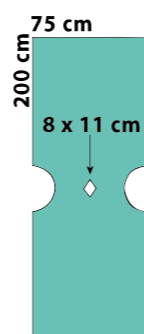

## Small Drapes

### Under Buttocks Drape **508887**

Dispenser, PU: 90 drapes

Description	Size/cm	Qty./disp.
Under buttocks drape, 2-ply with 20 cm turn-up	75 x 100	30

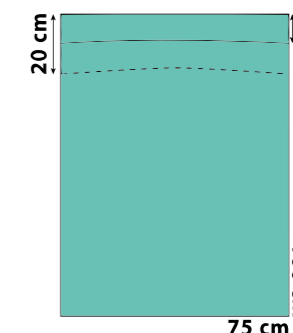

### Under Buttocks Drape **506667**

Dispenser, PU: 45 drapes

Description	Size/cm	Qty./disp.
Under buttocks drape, Colordrape, with 20 cm turn-up, 54 x 43 cm non-woven reinforcement and fluid collection pouch with scale, sieve and drainage port	100 x 120	15

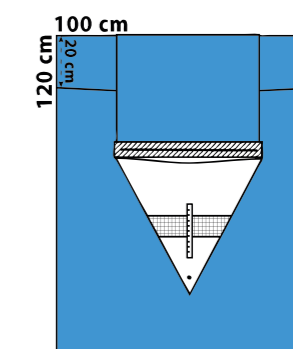

print version, leggings included on this page

### CYST Pack **561204**

PU: 20 packs

Cont. and sequence	Size/cm	Qty.	Ref. no.
Plain drape, 2-ply	75 x 90	1	508824
CYST drape, 2-ply, $\diamond$ 8 x 11 cm aperture, central	75 x 200	1	518842
Leggings, 2-ply	75 x 120	2	588812

### ~~CYST Pack, aquamarine~~ delete **861204**

PU: 20 packs

Cont. and sequence	Size/cm	Qty.	Ref. no.
Plain drape, 2-ply	75 x 90	1	808824
CYST drape, 2-ply, $\diamond$ 8 x 11 cm aperture	75 x 200	1	818842
Leggings, 2-ply	75 x 120	2	888812

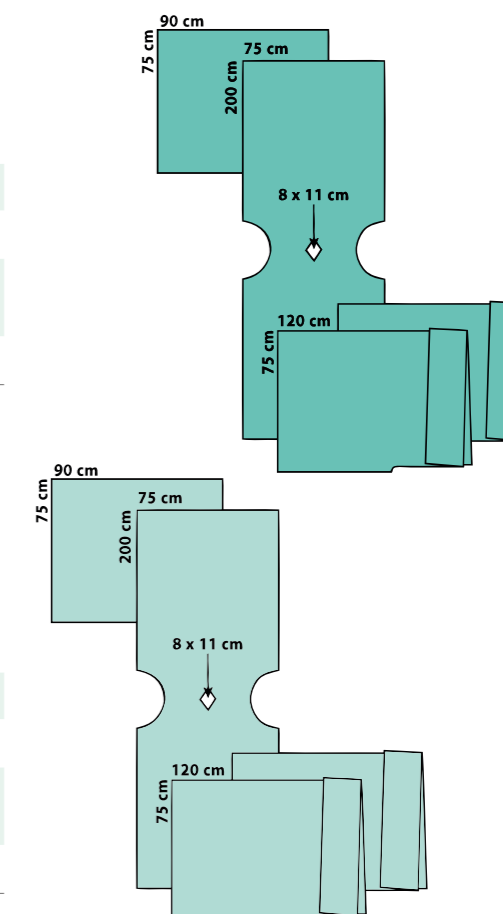

# Neurosurgery, ENT, OMS, Ophthalmology



The innovative neurosurgery drapes have a reinforced incision area and generous fluid collection pouch allows an effective fluid management.

The turban drape can be flexibly used in face surgery. Special eye and ENT drapes offer a user-friendly solution.

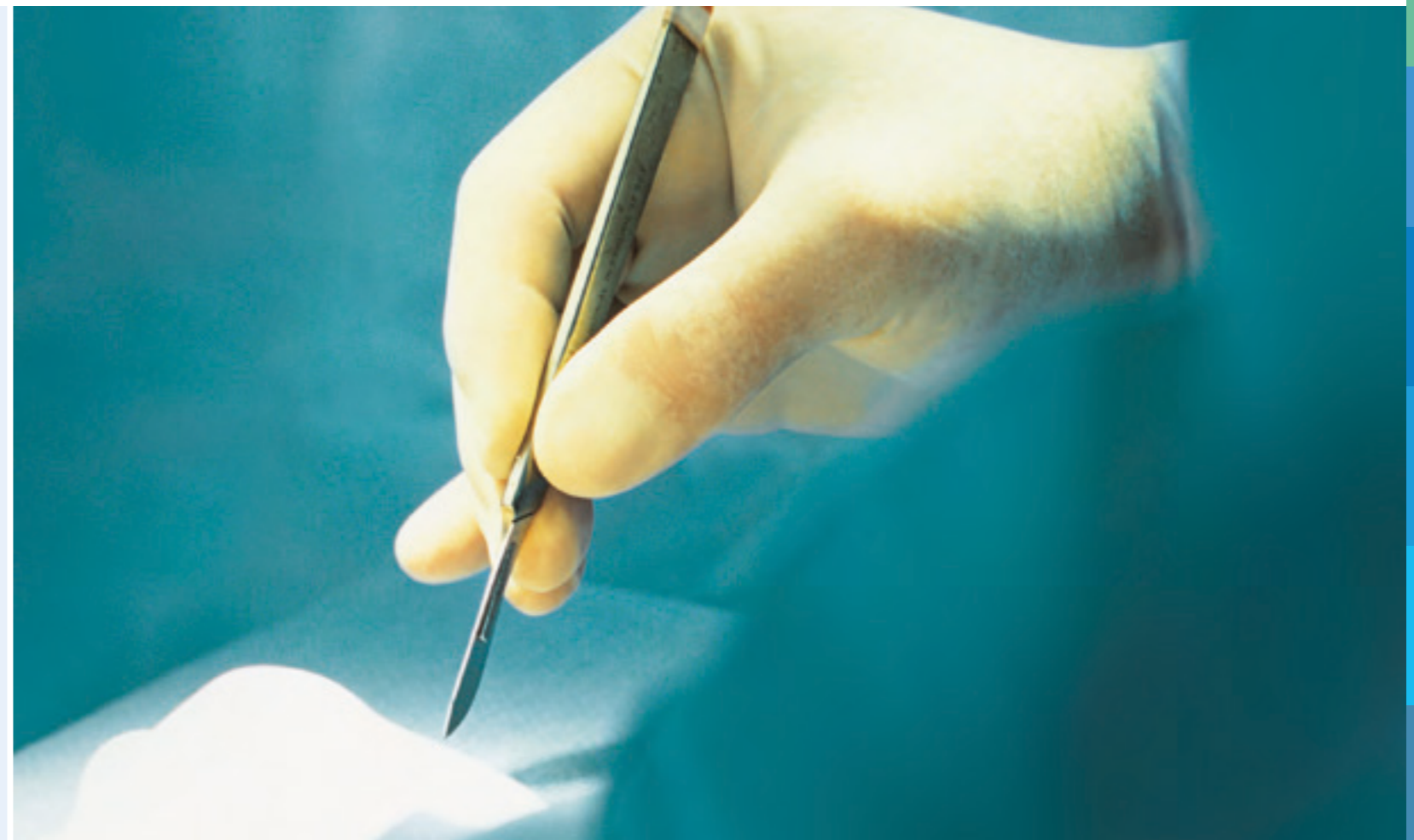

## Neurosurgery Drapes for cranial procedures

### Neurosurgery Drape, standard **558845**

PU: 14 drapes

Description	Size/cm
-------------	---------

Neurosurgery drape, 2-ply, with 25 x 20.5 cm aperture, with integral 48 x 80 cm incision film, partially as a reinforcement with fluid collection pouch with sieve and drainage port

300 x 225

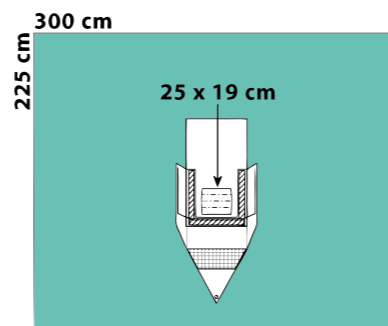

### Neurosurgery Drape, aquamarine **859140-9** delete

Description	Size/cm
-------------	---------

Neurosurgery drape, aquamarine 3-ply, with anti-slipping reinforcement, 30 x 19 cm aperture, with integral 50 x 80 cm incision film, partially as a reinforcement, 9 velcro strips. Separate: fluid collection pouch with sieve and drainage port

340 x 225

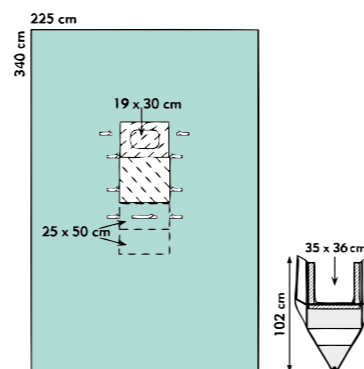

Only available as a non-sterile pack component

### Craniotomy Pack **564372** not in the print catalogue

PU: 12 packs

Cont. and sequence	Size/cm	Qty.	Ref. no.
Plain drape – table cover (wrap)	150 x 200	1	808869
Mayo stand cover	80 x 145	1	547714
Adhesive drape	50 x 50	1	538822
Velcro strip	2/2.5 x 25	1	592525
Neurosurgery drape, 2-ply, with 25 x 20.5 cm aperture, with integral 48 x 80 cm incision film, partially as a reinforcement with fluid collection pouch with sieve and drainage port	300 x 225	1	558845

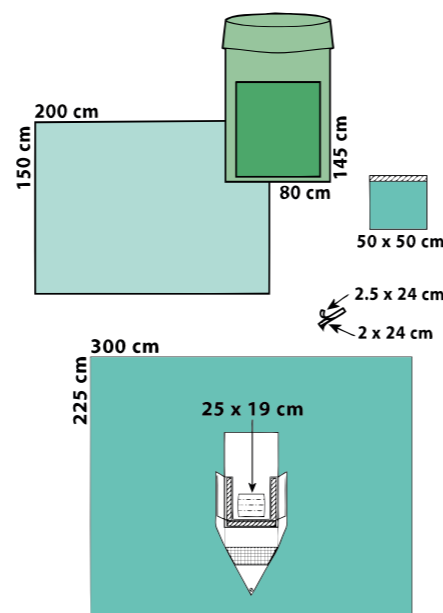

## Laminectomy Drapes for spinal procedures

### Laminectomy Drape **558808**

PU: 12 drapes

Description	Size/cm
-------------	---------

Laminectomy drape, 10.5 x 25 cm aperture, decentral, adhesive

225 x 320

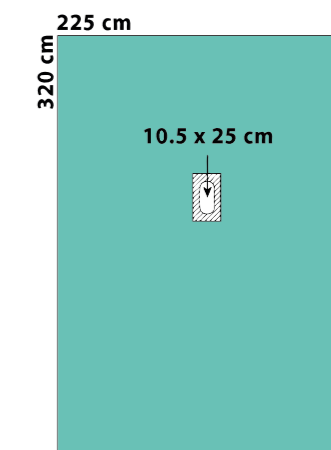

### Laminectomy Drape T-Form **559085-9**

Description	Size/cm
-------------	---------

Laminectomy drape, T-form, aperture 10 x 15 cm, decentral, adhesive

280/225 x 340

Only available as a non-sterile pack component

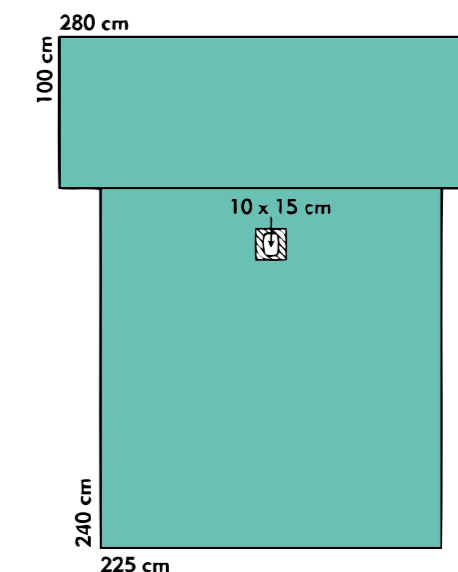

### Laminectomy Pack **563992** delete

PU: 14 packs

Cont. and sequence	Size/cm	Qty.	Ref. no.
Plain drape – table cover (wrap)	150 x 200	1	808869
Mayo stand cover	80 x 145	1	547714
Velcro strip	2/2.5 x 25	1	592525
Laminectomy drape, T-form, aperture 10 x 15 cm, decentral, adhesive	280/225 x 340	1	559085

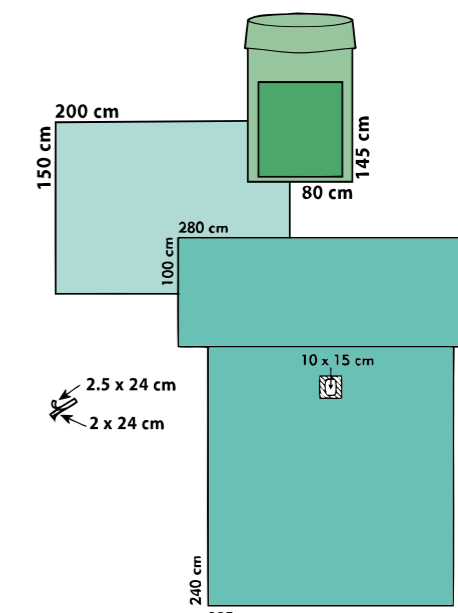

You will find further products in our separate ophthalmology brochure.

## Turban Drape

### Turban Drape **538919**

Dispenser, PU: 50 drapes

Description	Size/cm	Qty./disp.
Turban drape, 3-ply, 2-part, with adhesive areas	100/90 x 75	50

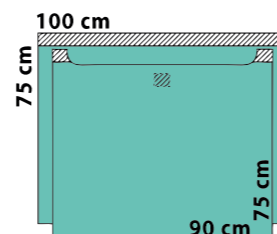

## ENT Drapes

### ENT Pack **563956** delete

PU: 14 packs

Cont. and sequence	Size/cm	Qty.	Ref. no.
Plain drape – table cover (wrap)	150 x 200	1	808869
Mayo stand cover	80 x 145	1	547714
Velcro strip	2/2.5 x 25	1	592525
Adhesive drape	75 x 100	1	538811
Split sheet U= 7,5 x 65 cm	200 x 260	1	528815

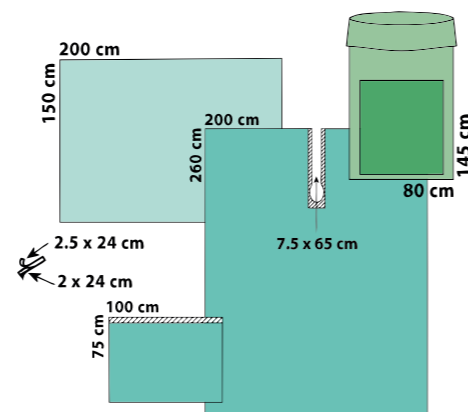

### Paediatrics/ENT Split Sheet **528815**

PU: 14 drapes

Description	Size/cm
Split sheet with 7.5 x 65 cm U-slit and special adhesive for sensitive skin	200 x 260

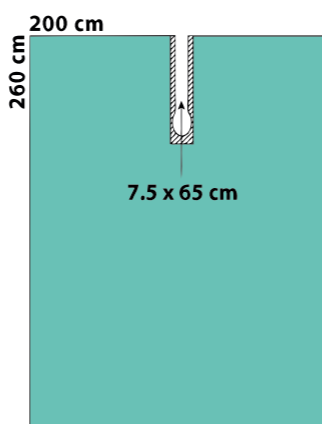

### OR Tape **592025**

Dispenser, PU: 420 tapes

Description	Size/cm	Qty./disp.
Non-woven, standard, adhesive layer impermeable to fluids	20 x 25	70

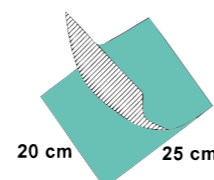

## Eye Drapes

### Eye Drape **585701**

Dispenser, PU: 60 drapes

Description	Size/cm	Qty./disp.
Eye drape, Mediwell soft, with 10 x 7 cm aperture with integral incision film and fluid collection pouch with pliable metal strip	120 x 150	20

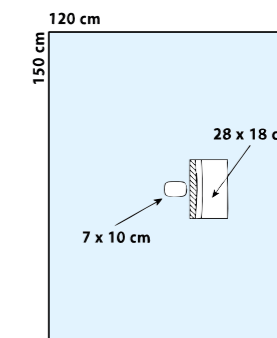

### ~~Eye Drape~~ **585703** delete

Dispenser, PU: 30 drapes

Description	Size/cm	Qty./disp.
Eye drape, Mediwell soft, with 10 x 7 cm aperture with dual fluid collection pouch with pliable metal strips and integral incision film	150 x 240	10

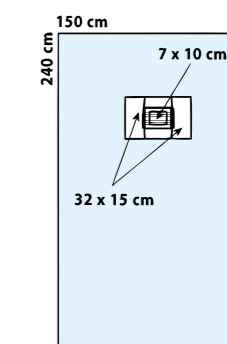

### Eye Drape **585731**

Dispenser, PU: 70 drapes

Description	Size/cm	Qty./disp.
Eye drape, Mediwell light, with 10 x 7 cm aperture, central, with integral incision film and fluid collection pouch with pliable metal strip	120 x 150	35

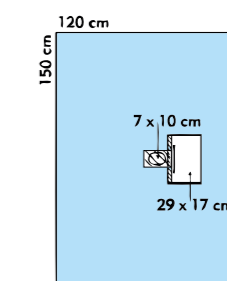

### Eye Drape **555751**

Dispenser, PU: 24 drapes

Description	Size/cm	Qty./disp.
Eye drape, Mediwell light, with 12 x 10 cm aperture, with dual fluid collection pouch with pliable metal strips and 2 nose strips	160 x 255	12

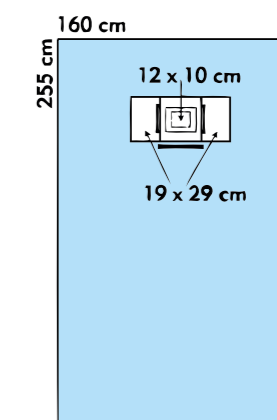

You will find further products in our separate ophthalmology brochure.

Eye Drapes

**Aperture Drape, Filmdrape 556601**

Dispenser, PU: 840 drapes

Description	Size/cm	Qty./disp.
Ø 6 cm aperture, adhesive	40 x 40	140

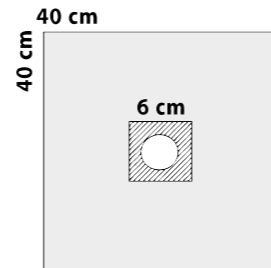

**Aperture Drape, Filmdrape 556602**

Dispenser, PU: 480 drapes

Description	Size/cm	Qty./disp.
Ø 6 cm aperture, adhesive	57 x 65	80

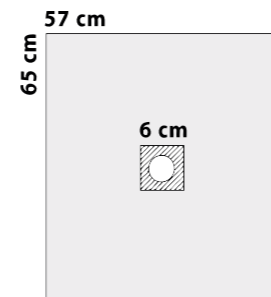

**Eye Drape, Filmdrape 556652**

Dispenser, PU: 150 drapes

Description	Size/cm	Qty./disp.
Ø 6 cm aperture, adhesive, with fluid collection pouch with pliable metal strip	57 x 65	50

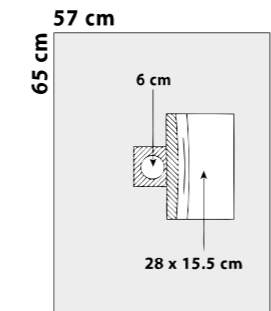

S- production on demand

**Eye Drape, Filmdrape 586601**

Dispenser, PU: 120 drapes

Description	Size/cm	Qty./disp.
Aperture 7.5 x 5 cm, adhesive, with fluid collection pouch with pliable metal strip	100 x 105	40

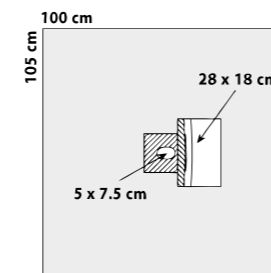

Supplementary Products

**Armrest Covers dispenser**

**Mediwell super, 2-ply**

Description	Size/cm	Qty./disp.	Ref. no.
with integral tape strip PU: 90 pairs	35 x 73	15 pairs	583573
elastified PU: 60 pairs	25 x 70	20 pairs	583574

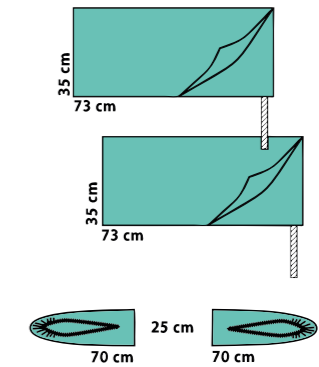

**Stool Cover dispenser**

Description	Size/cm	Qty./disp.	Ref. no.
Mediwell super, 2-ply PU: 90 covers	75 x 75	15	588875
Mediwell super, 2-ply elastified PU: 210 covers	60 x 60	35	588860

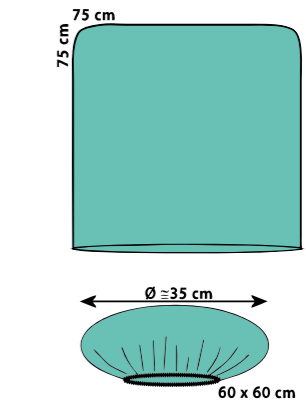

**Special Tie Gowns/SP for ophthalmology**

Description	Length/cm	Ref. no.
L	130	464423-9
L/XL	140	464462-9 delete
XL	150	464426-9

Only available as a non-sterile pack component

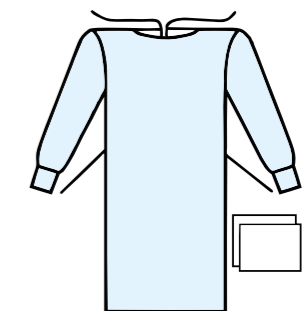

**Accessories dispenser**

Description	Size/cm	Qty./disp.	Ref. no.
Velcro strip PU: 600 pcs.	2/2.5 x 24	100	592525
Incision film PU: 900 pcs.	10 x 18	150	591018

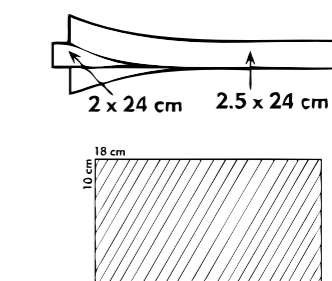

# Paediatrics



The child as a patient: Our product range includes a paediatric line with very skin-friendly adhesive tapes for the high quality demands of paediatric surgery.

Special extremity and aperture drapes are adapted to the proportions of infants and babies. Furthermore, we offer paediatric universal packs to ensure the best possible care of small patients.





## Paediatric Drapes and Pack

### Adhesive Drapes

**538914**

#### Mediwell super strong

Dispenser, PU: 120 drapes

Description	Size/cm	Qty./disp.
with special adhesive, 2.5 x 100 cm	75 x 100	40

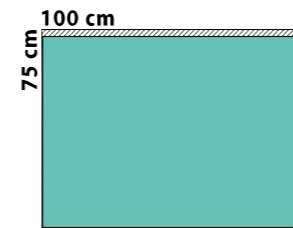

### Paediatrics Aperture Drapes, adhesive

#### Mediwell super or Mediwell super strong

Description	Size/cm	Qty.	Ref. no.
7 x 10 cm aperture, 2-ply Dispenser, PU: 75 drapes	100 x 150	25	558974
16 x 12 cm aperture Inliner, PU: 14 drapes	200 x 280	7	558809

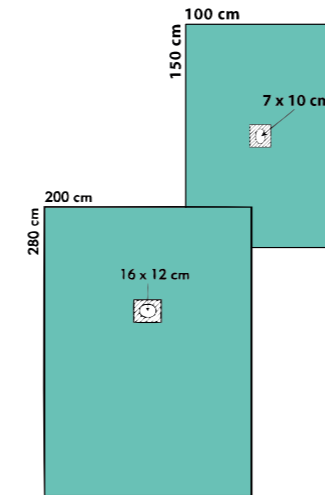

### Universal Pack, paediatrics

**561007**

PU: 7 packs

Cont. and sequence	Size/cm	Qty.	Ref. no.
Plain drape – table cover (wrap)	150 x 200	1	808869
Mayo stand cover	80 x 145	1	547714
Hand towels	25 x 20	4	-/-
OR tape, elastic	10 x 50	1	591151
Side drape	75 x 100	2	538914
Foot drape	175 x 180	1	538916
Head drape	150 x 240	1	538917

Particularity: with special adhesive for sensitive skin and 2.5 cm wide adhesive zones.

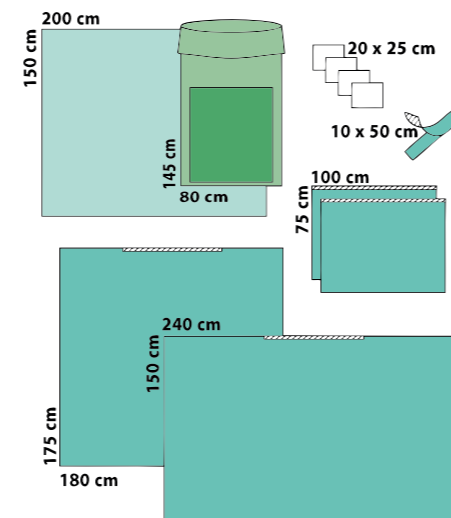

### Extremity Drape

**518815**

#### Mediwell super strong

PU: 12 drapes

Description	Size/cm
Hand/foot extremity drape, with Ø 3 cm elastic aperture, decentral, for hand/foot or child extremities	225 x 300

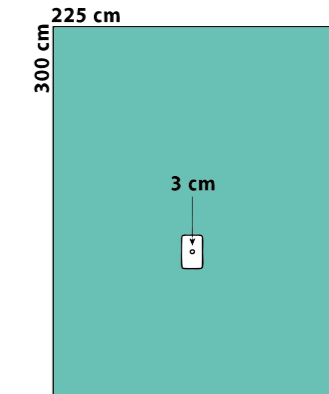

### Split Sheet, paediatrics

**528815**

#### Mediwell super strong

PU: 14 drapes

Description	Size/cm
U=7.5 x 65 cm, adhesive	200 x 260

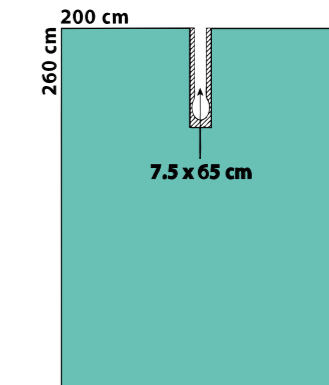

### Accessories dispenser

Description	Size/cm	Qty./disp.	Ref. no.
Child stockinette, 2-ply with OR tape PU: 180 pcs.	17 x 75	60	588827
OR tape, elastic PU: 750 pcs.	10 x 50	125	591151

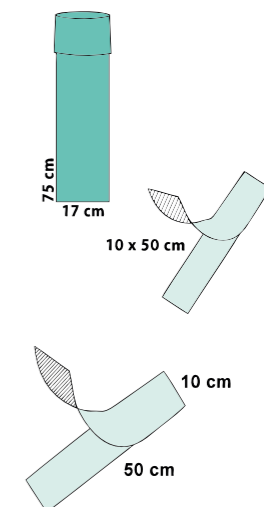

# Day Surgery



Full flexibility combined with highest quality standards: To fulfil the special requirements of day surgeries, we have a wide range of products including various packs and drapes, OR tape and mayo stand covers. This applies not only to general surgery: You can also count on our indication-related and user-friendly solutions in the fields of orthopaedic and traumatologic surgery as well as in gynaecology and urology.



## General Surgery

### Universal Pack, standard

**561088**

PU: 7 packs

Cont. and sequence	Size/cm	Qty.	Ref. no.
Plain drape – table cover (wrap)	150 x 200	1	808869
Mayo stand cover	80 x 145	1	547714
Hand towels	25 x 20	4	-/-
OR tape	10 x 50	1	591050
Side drapes	75 x 100	2	538811
Foot drape	175 x 180	1	538806
Head drape	150 x 240	1	538807

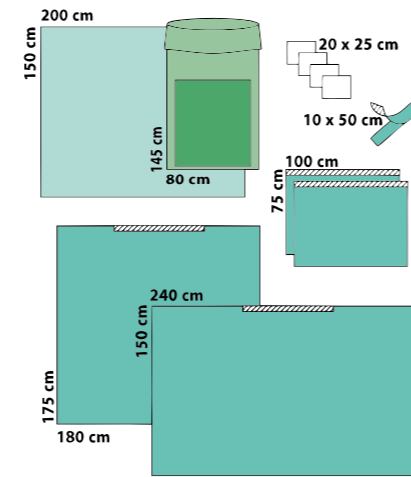

### Split Sheet Pack, standard

**561112**

PU: 7 packs

Cont. and sequence	Size/cm	Qty.	Ref. no.
Plain drape – table cover (wrap)	150 x 200	1	808869
Mayo stand cover	80 x 145	1	547714
Hand towels	25 x 20	4	-/-
Bottom drape, Mediwell, 3-ply	150 x 180	1	501518
Split sheet, U=7.5 x 100 cm	200 x 260	1	528805
Adhesive drape	150 x 240	1	538807

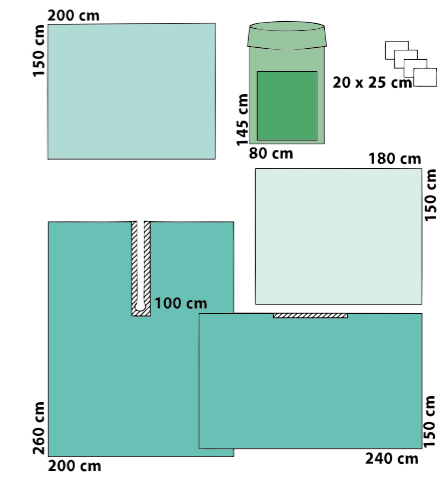

### Universal Pack, aquamarine

delete **861088**

PU: 8 packs

Cont. and sequence	Size/cm	Qty.	Ref. no.
Plain drape – table cover (wrap)	150 x 200	1	808869
OR tape	10 x 50	1	591050
Hand towels	25 x 20	2	-/-
Mayo stand cover	80 x 145	1	547714
Side drapes, 2-ply	75 x 90	2	838823
Foot drape	180 x 175	1	838806
Head drape	150 x 240	1	838807

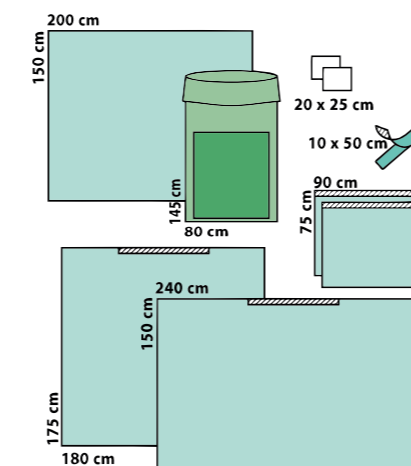

### Shoulder Split Sheet Pack, aquamarine

delete **861112**

PU: 7 packs

Cont. and sequence	Size/cm	Qty.	Ref. no.
Plain drape – table cover (wrap)	150 x 200	1	808869
Mayo stand cover	80 x 145	1	547714
Stockinette	33 x 73	1	883355
OR tape, elastic	10 x 50	2	591151
Plain drape, 2-ply, as bottom drape	150 x 180	1	808821
Split sheet, U=7.5 x 100 cm	200 x 260	1	828805
Adhesive drape	150 x 240	1	838807
Hand towels	25 x 20	2	-/-

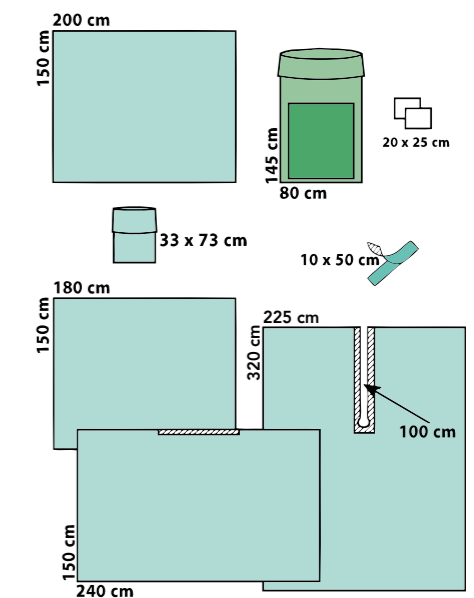

## Traumatology and Orthopaedic Surgery

### Arthroscopy Pack, standard 1 **561105**

PU: 9 packs

Cont. and sequence	Size/cm	Qty.	Ref. no.
Plain drape – table cover (wrap)	85 x 100	1	808869
Mayo stand cover	80 x 145	1	547714
Hand towels	20 x 25	4	-/-
Stockinette, 2-ply	33 x 73	1	583355
OR tape, film	11 x 50	2	591150
Extremity drape with Ø 7 cm elastic aperture with cable/ tube holder	225 x 325	1	518810

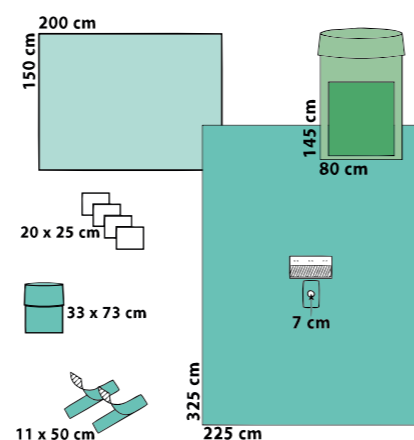

### Arthroscopy Pack, standard 3 **563035**

PU: 6 packs

Cont. and sequence	Size/cm	Qty.	Ref. no.
Plain drape – table cover (wrap)	85 x 100	1	808869
Hand towels	30 x 40	2	-/-
OR gown, standard	XL = 150	1	464416
OR gown, reinforced	XL = 150	1	464417
Mayo stand cover	80 x 145	1	547714
Stockinette, 2-ply	33 x 73	1	583355
OR tape, film	11 x 50	2	591150
Camera tube cover, telescopically	13 x 250	1	581323
Extremity drape, 2-ply, with Ø 7 cm elastic aperture, decentral and integral velcro strip	200 x 300	1	518819

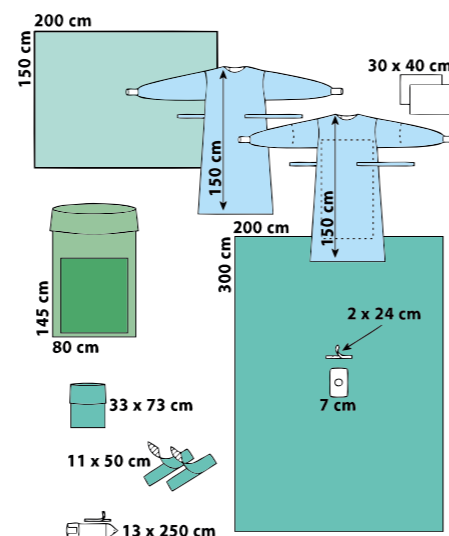

### Arthroscopy Drape, "small" **518853**

PU: 24 drapes

Description	Size/cm
Arthroscopy drape "small", 2-ply, with cable/tube holder and fluid collection pouch with drainage port	200 x 300

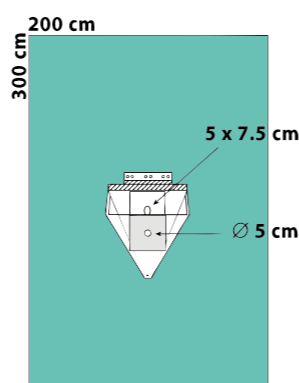

### Arthroscopy Pack, aquamarine **861122** delete

PU: 10 packs

Cont. and sequence	Size/cm	Qty.	Ref. no.
Plain drape – table cover (wrap)	150 x 200	1	808869
Mayo stand cover	80 x 145	1	547714
Stockinette, 2-ply	33 x 73	1	883355
OR tape, film	11 x 50	2	591150
Camera tube cover, telescopically	13 x 250	1	581323
Velcro strip	2/2.5 x 24	1	592525
Extremity drape, with Ø 7 cm elastic aperture	200 x 300	1	818820

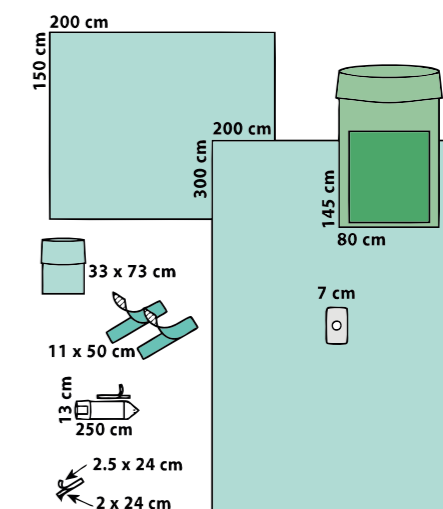

### Hand Surgery Drape **518844**

PU: 20 drapes

Description	Size/cm
Hand Surgery drape, 2-ply, T-form, with integral arm table cover and elastic aperture Ø 3 cm	360/150 x 330

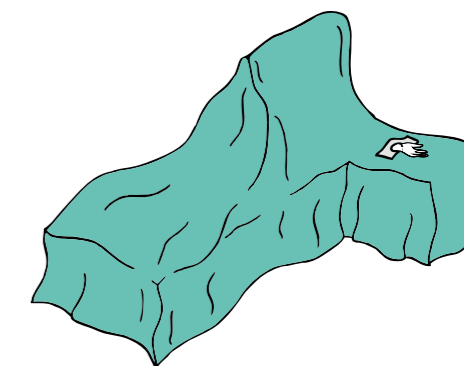

### Hand Surgery Drape **518845**

PU: 20 drapes

Description	Size/cm
Hand surgery drape, 2-ply, T-form, with integral arm table cover and elastic aperture Ø 3 cm	360/160 x 280

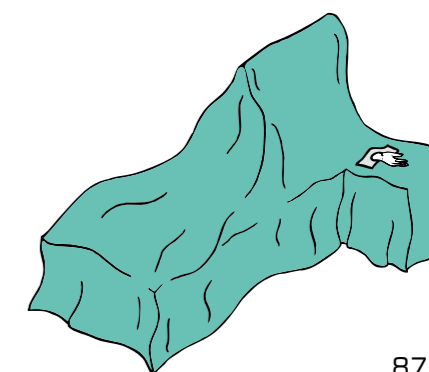

## Traumatology and Orthopaedic Surgery

### Hand/Foot Pack

**564185**

PU: 10 packs

Cont. and sequence	Size/cm	Qty.	Ref. no.
Plain drape – table cover (wrap)	150 x 200	1	808869
Mayo stand cover	80 x 145	1	547714
Hand/Foot drape	225 x 300	1	518815

Particularity: with larger back table cover

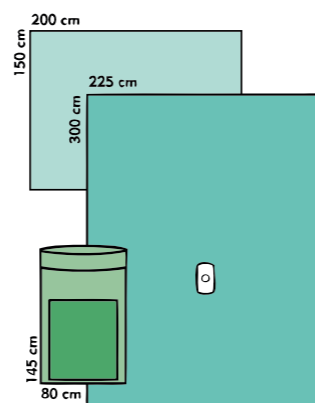

### Hand/Foot Pack, aquamarine

**818815-9** delete

Description	Size/cm
Extremity drape, 2-ply with Ø 3 cm elastic aperture	225 x 300

Only available as a non-sterile pack component

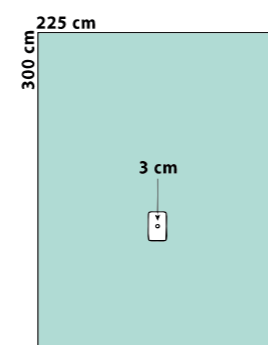

### Extremity Drape "small"

**518827**

Dispenser, PU: 40 drapes

Description	Size/cm	Qty./disp.
Extremity drape, 2-ply with Ø 4 cm elastic aperture	150 x 200	20

For procedures on the distal extremities

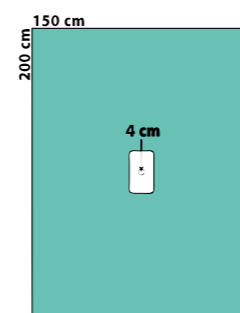

### Extremity Drape

**518820**

PU: 16 drapes

Description	Size/cm
Extremity drape, 2-ply with Ø 7 cm elastic aperture	200 x 300

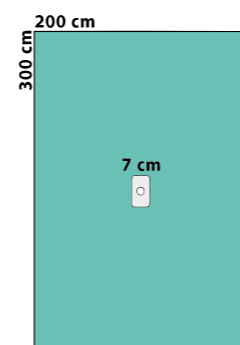

## Aperture Drapes/Packs

### Aperture Drape, aquamarine

**859176** delete

PU: 20 drapes

Description	Size/cm
Adhesive aperture Ø 16 cm, central	200 x 280

Hier Text eingeben

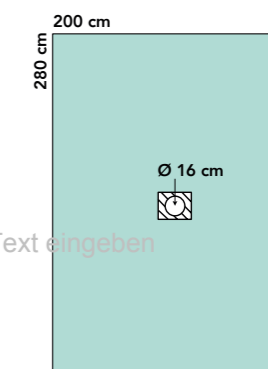

### Aperture Drape Pack "small", aquamarine

**864373** delete

PU: 14 packs

Cont. and sequence	Size/cm	Qty.	Ref. no.
Plain drape – table cover (wrap)	150 x 200	1	808869
Hand towels	20 x 25	2	-/-
OR tape, elastic	10 x 50	1	591151
Adhesive aperture Ø 16 cm, central, aquamarine	200 x 280	1	859176

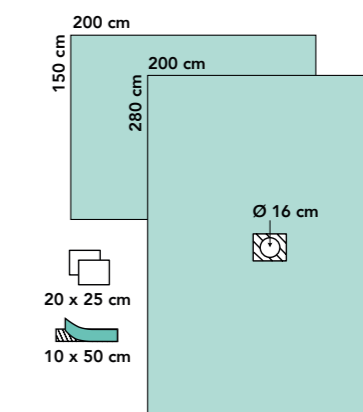

### Aperture Drape, Mediwell super strong

**559175**

PU: 20 drapes

Description	Size/cm
Adhesive aperture Ø 13 cm, central	200 x 240

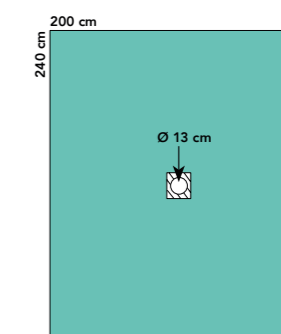

S- special production

### Aperture Drape Pack "small" S- special production

**564373**

PU: 14 packs

Cont. and sequence	Size/cm	Qty.	Ref. no.
Plain drape – table cover (wrap)	150 x 200	1	808869
Hand towels	20 x 25	2	-/-
OR tape, elastic	10 x 50	1	591151
Adhesive aperture Ø 13 cm, central	200 x 240	1	559175

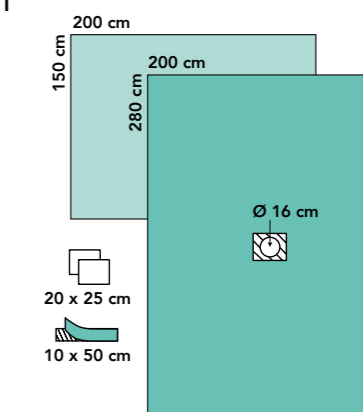

### TUR Pack, standard

PU: 14 packs

**561202**

Cont. and sequence	Size/cm	Qty.	Ref. no.
Plain drape – table cover (wrap)	100 x 150	1	808823
Hand towels	20 x 25	4	-/-
TUR drape with 6 x 10 cm adhesive aperture; with sieve, finger cot and Ø 6 cm supra-pubic aperture with incision film	225 x 260	1	558882

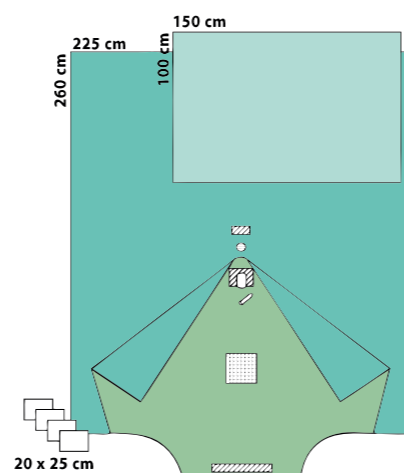

### ~~CYST Pack, aquamarine~~

PU: 20 packs

delete **861204**

Cont. and sequence	Size/cm	Qty.	Ref. no.
Plain drape, 2-ply	75 x 90	1	808824
CYST drape, 2-ply, ◇ 8 x 11 cm aperture	75 x 200	1	818842
Leggings, 2-ply	75 x 125	2	888812

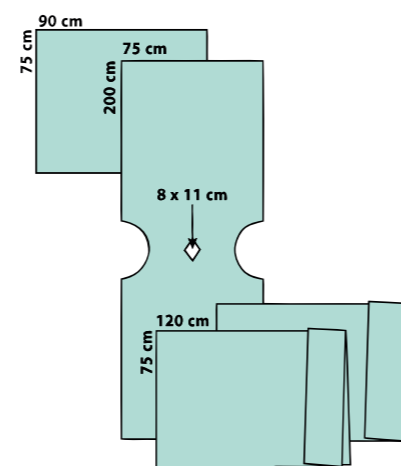

### TUR Drape

Dispenser, PU: 45 drapes

**518841**

Description	Size/cm	Qty./disp.
TUR drape, 2-ply, ◇ 8 x 11 cm non-adhesive aperture, decentral; with sieve	100 x 230	15

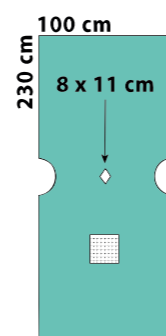

### Under Buttocks Drape

Dispenser, PU: 90 drapes

**508887**

Description	Size/cm	Qty./disp.
Under buttocks drape, 2-ply with 20 cm turn-up	75 x 100	30

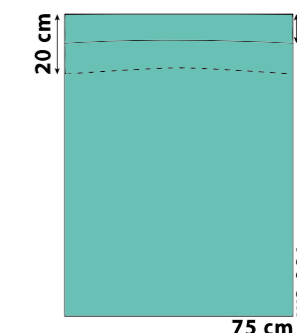

### Under Buttocks Drape

Dispenser, PU: 45 drapes

**506667**

Description	Size/cm	Qty./disp.
Under buttocks drape, Colordrape, with 20 cm turn-up, 54 x 43 cm non-woven reinforcement and fluid collection pouch with scale, sieve and drainage port	100 x 120	15

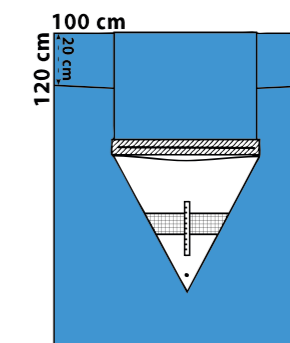

### ~~Leggings~~

Dispenser, PU: 30 pairs

**888812** delete

Description	Length/cm	Qty./disp.
aquamarine 2-ply	75 x 120	10 pairs

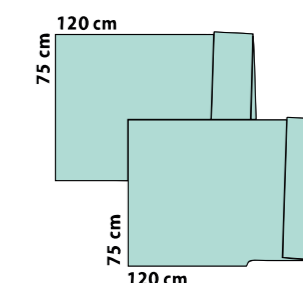

## Plain Drapes

Mediwell 2-ply	Qty. dispenser or inliner/PU	Size/cm	Ref. no.
	120 / 720	37.5 x 45	503842
	70 / 420	45 x 75	504572
	45 / 270	75 x 90	507592
<b>Mediwell 3-ply</b>			
	<del>65 / 390</del>	45 x 75	504575 X delete
	35 / 210	75 x 90	507590
<b>Mediwell super 2-ply</b>			
	60 / 360	45 x 75	508825
	40 / 240	75 x 90	508824
	30 / 180	100 x 100	508858
	20 / 60	100 x 150	508823
<b>aquamarine 2-ply</b>			
	27 / 81	100 x 150	808823
	18 / 54	150 x 140	808844-9 non-sterile

## Adhesive Drapes

Mediwell super 2-ply	Qty. dispenser or inliner/PU	Size/cm	Ref. no.
Adhesive zone 5 x 50 cm	70 / 420	50 x 50	538822
Adhesive zone 5 x 75 cm	65 / 390	50 x 75	538829
Adhesive zone 5 x 75 cm	45 / 270	75 x 75	538821
Adhesive zone 5 x 90 cm	40 / 240	75 x 90	538823

## Colordrape

Mayo stand covers made of PE film	Qty. dispenser or inliner/PU	Size/cm	Ref. no.
"Standard", non-woven area 75 x 64 cm, turquoise	20 / 60	80 x 145	547714

## Aperture Drapes

Mediwell 2-ply	Qty. dispenser or inliner/PU	Size/cm	Ref. no.
Aperture Ø 6 cm, central	70 / 420	45 x 75	514572
Aperture Ø 6 cm, central	45 / 270	75 x 90	517592
<b>Mediwell 3-ply</b>			
<del>Aperture Ø 6 cm, central</del>	50 / 300	45 x 75	514575 X delete
<del>Aperture Ø 6 cm, central</del>	30 / 180	75 x 90	517590 X delete
<b>Mediwell super 2-ply</b>			
Aperture Ø 6 cm, central	70 / 420	45 x 75	518821
Aperture Ø 6 cm, central	45 / 270	75 x 90	518822

## Aperture Drapes, Adhesive

Mediwell 2-ply	Qty. dispenser or inliner/PU	Size/cm	Ref. no.
Aperture oval, 5 x 7.5 cm, central	65 / 390	50 x 60	555064
<b>Mediwell super 2-ply</b>			
Aperture Ø 6 cm, central	70 / 420	50 x 60	558823
Aperture Ø 6 cm, central	45 / 270	75 x 75	558971
Aperture oval, 8 x 6 cm, central	40 / 240	75 x 90	558972
Aperture oval, 7 x 10 cm, central	25 / 75	100 x 150	558974
<b>Mediwell super strong 3-ply</b>			
Aperture 15 x 15 cm, central	18 / 54	120 x 150	559075
Aperture 7.5 x 5 cm, decentral	15 / 45	120 x 150	558801

## Film drape

Aperture Ø 6 cm, central	50 / 150	75 x 130	556655	S- special production
--------------------------	----------	----------	--------	-----------------------

## Supplementary Products

### Diathermy Pouches, adhesive, transparent

Dispenser

Description	Size/cm	Qty./disp.	Ref. no.
Single chamber, with turn-up PU: 6 dispenser	33 x 28	60	583330

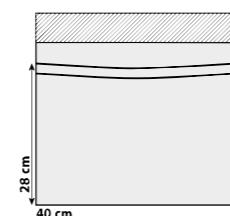

### OR Tapes dispenser

Description	Size/cm	Qty./disp.	Ref. no.
non-woven, standard PU: 6 dispenser	10 x 50	130	591050
non-woven, elastic PU: 6 dispenser	10 x 50	125	591151

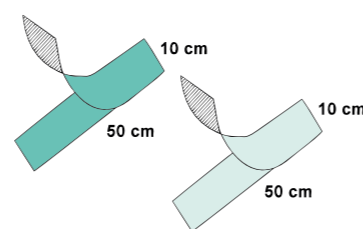

### Stockinettes dispenser

Description	Size/cm	Qty./disp.	Ref. no.
2-ply + 2 film tapes PU: 120 stockinettes	33 x 73	40	583355
2-ply + 2 film tapes PU: 75 stockinettes	35 x 120	25	583311
US model PU: 150 stockinettes	23 x 80	25	580001
US model PU: 51 stockinettes	32 x 120	17	580003

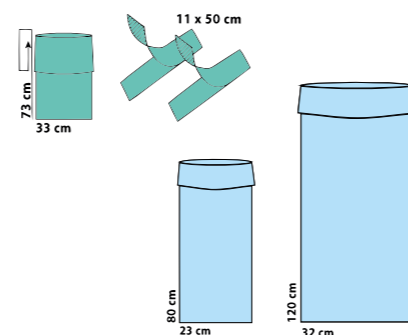

## Variable Aperture Drapes

### Variable Aperture Drapes, adhesive, 2-ply

Mediwell super 2-ply	Qty. dispenser or inliner/PU	Size/cm	Ref. no.
Aperture max. 12 x 21 cm	50 / 300	50 x 75	554575
Aperture max. 12 x 21 cm	35 / 210	75 x 90	558948
Aperture max. 18 x 28 cm	30 / 180	75 x 90	558964

### Variable Split Sheet Pack

S- special production

**561115**

PU: 8 packs

Cont. and sequence	Size/cm	Qty.	Ref. no.
Plain drape – table cover (wrap)	150 x 200	1	808869
Split sheet, U = 19 x 19 cm	150 x 200		528837
Split sheet, U = 20 x 65 cm	150 x 260		528862

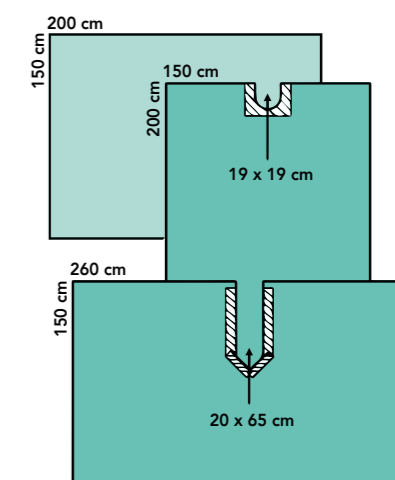



## Supplementary Products



For holistic comprehensive supplies of the operating theatre, Sengewald offers a multitude of application-friendly supplementary products. Various collection pouches for direct fluid control, diathermy bags, OR tape and velcro fasteners as well as sleeve protectors, leggings and foot covers are available in various materials and measurements.

Camera covers and image intensifier packs, as well as equipment covers in diverse sizes guarantee maximum hygiene safety in the OR.

Hier Text eingeben



# Supplementary Products

## Fluid Collection/Diathermy Pouches

### Fluid Collection Pouches

Description	Size/cm	PU	Ref. no.
For shoulders, with 46 cm adhesive U-slit and 2 drainage ports	59/80 x 76	50	589978
Universal, with sieve and drainage port	55 x 50/44	50	589901

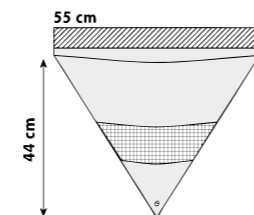
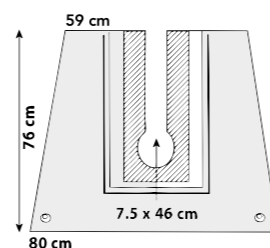

### Diathermy Pouches, adhesive, transparent

Dispenser

Description	Size/cm	Qty.	Ref. no.
Single chamber, with bottom fold 5 cm PU: 6 dispenser	33 x 22.5	52	583324
Single chamber, with turn-up PU: 6 dispenser	33 x 28	60	583330
Single chamber, with turn-up PU: 6 dispenser	40 x 28	60	584028
Dual chamber, 27 + 14 cm PU: 6 dispenser	44 x 27	60	584427
MIS single chamber PU: 6 dispenser	50 x 30	45	583850
MIS triple chamber, with turn-up PU: 6 dispenser	24 x 38.5	50	582246
Single chamber, hip PU: 3 dispenser	100 x 64	25	588010

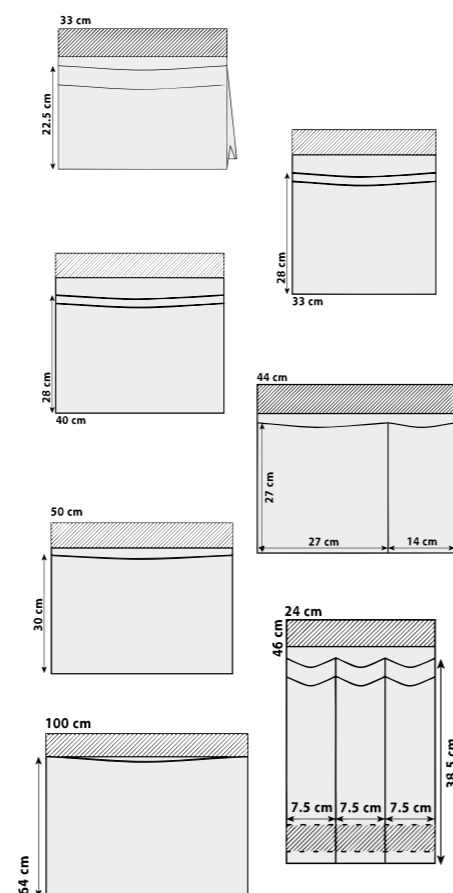

## Velcro Strip/OR Tapes/Incision Film

### Velcro Strip dispenser

Description	Size/cm	Qty.	Ref. no.
OP velcro strip PU: 6 dispenser	2/2.5 x 24	100	592525

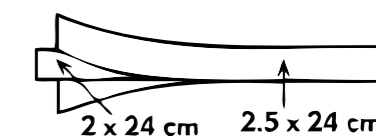

### OR Tapes dispenser

Description	Size/cm	Qty.	Ref. no.
Non-woven, standard PU: 6 dispenser	10 x 50	130	591050
Non-woven, elastic PU: 6 dispenser	10 x 50	125	591151
Film PU: 6 dispenser	11 x 50	110	591150
<del>Non-woven, standard</del> PU: 6 dispenser	20 x 25	70	592025 delete
Non-woven, standard PU: 6 dispenser	10 x 25	100 pairs	591025
Non-woven, elastic PU: 6 dispenser	10 x 50	75 pairs	591152
Non-woven, elastic à 5 pcs. PU: 6 dispenser	10 x 50	25 x 5 pouches	591055 S- special production

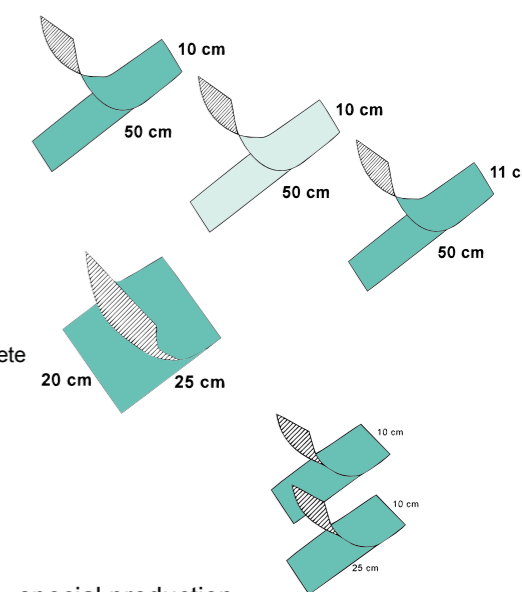

### Incision Film dispenser

Description	Size/cm	Qty.	Ref. no.
For ophthalmology PU: 6 dispenser	10 x 18	150	591018

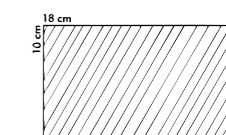

# Supplementary Products

## Foot Covers/Stockinettes/Leggings

### Foot Covers dispenser

Description	Size/cm	Qty./disp.	Ref. no.
Foot covers, 2-ply PU: 180 pairs	23-32 x 42	30	589950
Foot covers, transparent PU: 300 pairs	25-34 x 45	50	589951

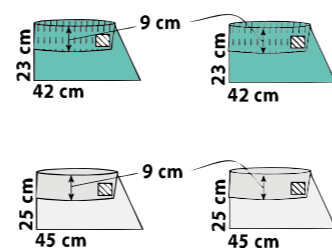

### Stockinettes dispenser

Description	Size/cm	Qty./disp.	Ref. no.
Mediwell super + 2 film tape strips PU: 120 stockinettes	33 x 73	40	583355
Mediwell super + 2 film tape strips PU: 75 stockinettes	35 x 120	25	583311
Mediwell super + elastic tape strip PU: 180 stockinettes	17 x 75	60	588827
US model PU: 150 stockinettes	23 x 80	25	580001
US model PU: 90 stockinettes	23 x 110	15	580002
US model PU: 51 stockinettes	32 x 120	17	580003

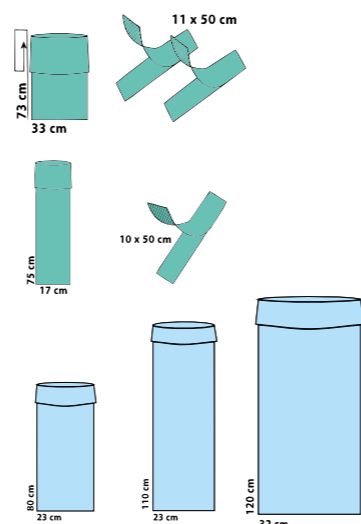

### GYN/URO Leggings dispenser

Description	Size/cm	Qty./disp.	Ref. no.
Mediwell super, 2-ply, film inside PU: 60 pairs	50 x 110	10	588811
Mediwell super, 2-ply, film inside PU: 36 pairs	75 x 120	12	588812
aquamarine, 2-ply, film inside PU: 30 pairs	75 x 120	10	888812 delete

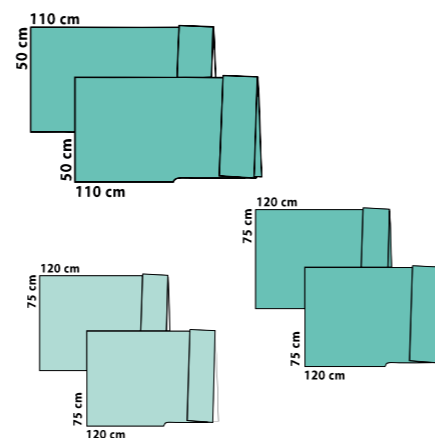

### Sleeve Protectors, Mediwell super dispenser

Description	Size/cm	Qty./disp.	Ref. no.
2-ply, with cuffs PU: 210 pcs.	22.5 x 57	35	582052

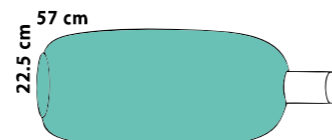

## Camera-/Image Intensifier Covers

### Camera Tube Covers dispenser

Description	Size/cm	Qty./disp.	Ref. no.
Camera tube cover, reverse PU: 210 covers	13 x 250	35	581322
Camera tube cover, telescopically PU: 192 covers	13 x 250	32	581323
Camera tube cover, telescopically PU: 192 covers	13 x 250	32	581324
Camera tube cover, telescopically PU: 150 covers	13 x 250	25	581325
Camera tube cover, telescopically PU: 120 covers	18 x 250	30	581825

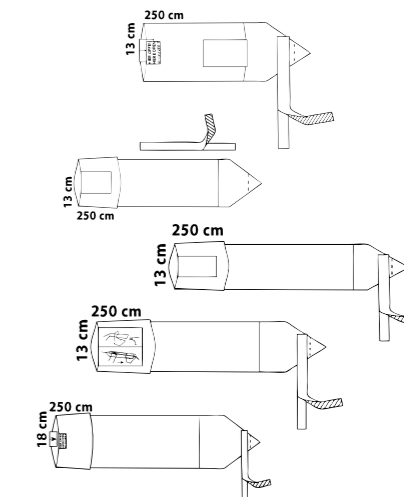

### Image Intensifier Covers and Packs dispenser

Description	Qty./disp.	Ref. no.
Pack 1, for Philips equipment, 3-part PU: 54 packs	18	565803
Pack 2, for Siemens equipment, 1-part with 2 OR tapes PU: 30 packs	10	565804
Pack 3, for Philips BV29 equipment, 3-part PU: 24 packs	24	565805
Pack 4, for Siemens ISO-C equipment, 1-part with 2 OR tapes PU: 50 packs	50	565851
Pack 6, for Siemens equipment, 1-part with 3 OR tapes PU: 30 packs	10	565856

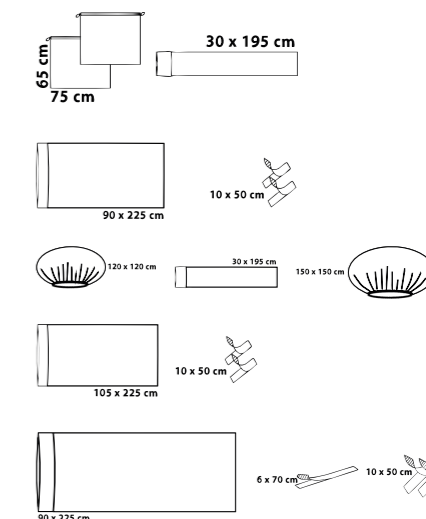

### Image Intensifier Cover dispenser

Description	Size/cm	Qty./disp.	Ref. no.
Film pouch with drawstring PU: 105 covers	75 x 65	35	587565

## Equipment Covers

### Stool Covers

Dispenser

Description	Size/cm	Qty./disp.	Ref. no.
Mediwell super, 2-ply PU: 90 covers	75 x 75	15	588875
Mediwell super, 2-ply elastified PU: 210 covers	60 x 60	35	588860

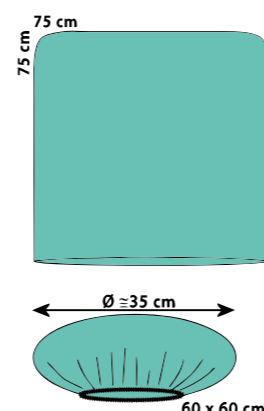

### Armrest Covers, Mediwell super, 2-ply

Dispenser

Description	Size/cm	Qty./disp.	Ref. no.
with integral tape strip PU: 90 pairs	37.5 x 73	15 pairs	583573
elastified PU: 60 pairs	25 x 70	20 pairs	583574

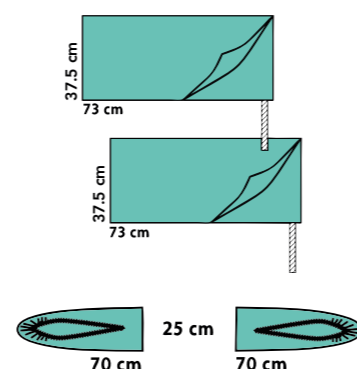

### X-Ray Cassette Cover, Mediwell

Dispenser

Description	Size/cm	Qty./disp.	Ref. no.
3-ply, adhesive, overall length 58 cm PU: 240 covers	50 x 50	40	585050

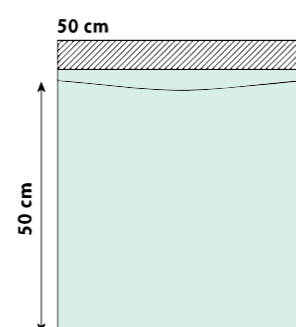

### Equipment Covers, transparent film

Dispenser

Description	Size/cm	Qty./disp.	Ref. no.
<del>elastified, round</del> PU: 300 pcs.	25 x 25	50	582515 delete
elastified, round Only available as a non-sterile pack component	45 x 45		584520-9
elastified, round PU: 180 pcs.	60 x 60	30	586030
elastified, round PU: 150 pcs.	80 x 80	25	588040
elastified, rectangular PU: 240 pcs.	80 x 45	40	588045
elastified, rectangular PU: 150 pcs.	110 x 80	25	581180
elastified, round PU: 120 pcs.	100 x 100	20	581050
elastified, round PU: 72 pcs.	120 x 120	12	581260
elastified, round Only available as a non-sterile pack component	150 x 150		581576-9

Example: equipment cover round

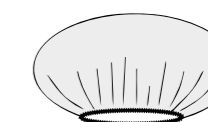

Example: equipment cover rectangular

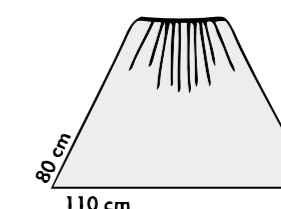
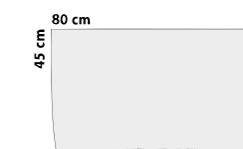

### Lead Window Cover, transparent film

Dispenser

Description	Size/cm	Qty./disp.	Ref. no.
with drawstring PU: 75 pcs.	80 x 110	25	588011

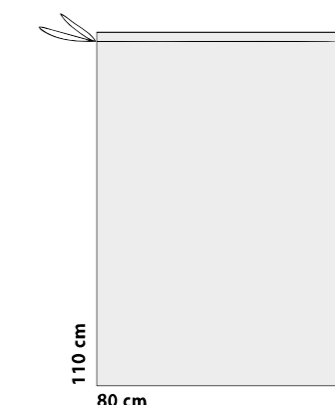

### Film Pouch, transparent film

Dispenser

Description	Size/cm	Qty./disp.	Ref. no.
with drawstring PU: 240 pcs.	65 x 60	40	586560

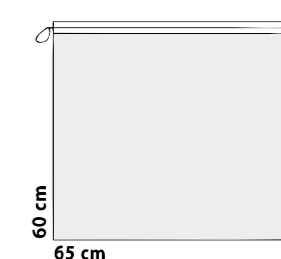

# Supplementary Products

## Accessory

### Surgical Suture Bag of transparent film

Description	Size/cm	Ref. no.
Film, PE/PA/PE, adhesive, with 3 pouches 67 x 90 mm	19.5 x 22.5	589960-9

Only available as a non-sterile pack component

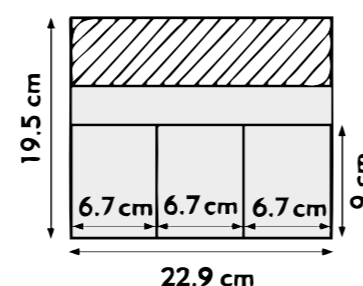

### Pillowcase Cover non-sterile

PU: 250 covers

Description	Size/cm	Qty.	Ref. no.
Pillowcase, Mediwell super, 2-ply	40 x 50	50	588851-9

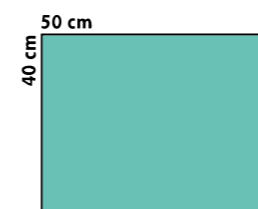

### OR Plain Drapes, rolled

Description	Size/cm	Qty.	Ref. no.
Plain drape, rolled PU: 50 pcs.	7 x 16	50	588880
Plain drape, rolled PU: 9 pcs.	16 x 30	9	588881
Plain drape, rolled PU: 3 pcs.	30 x 30	3	588882

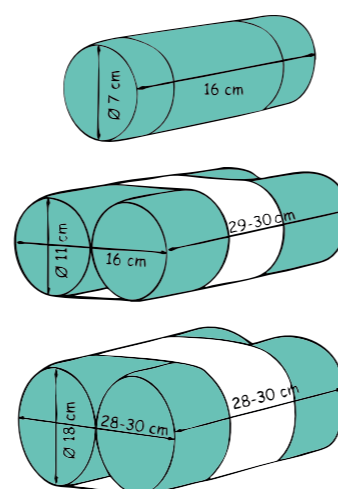

### Perineal Drape Mediwell super, 2-ply

Dispenser, PU: 300 pcs.

Description	Size/cm	Qty./disp.	Ref. no.
Adhesive with elasticated side	50/22 x 53	50	585053

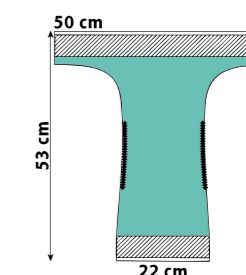

### Elastic Inlets non-sterile

Description	Size/cm	Qty.	Ref. no.
Aperture Ø 7 cm, central PU: 1,000 pcs.	25 x 40	100	582540-9
Aperture Ø 7 cm, central PU: 500 pcs.	40 x 40	50	584040-9

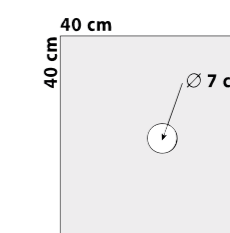

### Standcover for Bowl

PU: 75 covers

Description	Size/cm	Qty.	Ref. no.
with rubber band, Mediwell super, 2-ply	100 x 60	25	588877

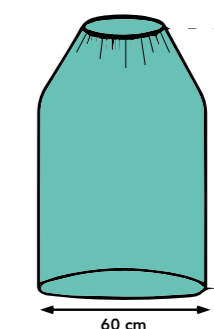

# OR Gowns



Our OR gowns ensure safety for personnel and patients: Mediwell soft is comfortable to wear due to its textile-like structure and the lightweight Mediwell light quality offers optimal patient comfort.

Thanks to the wide range including products in various materials and sizes the suitable gown for every intervention can be selected. All OR gowns are free of latex and PVC.



## OR Gowns Standard/Reinforced

**Gowns made of Mediwell soft** spunlace non-woven, breathable, textile-like structure, fluid-repellent; each gown is supplied with **two 30 x 40 cm hand towels and overwrap**

### Standard Gowns/SP without reinforcement

Description	Length/cm	PU	Ref. no.
L	130	24	464413
XL	150	24	464416
XXL	170	22	464419
XL, extra wide (hem 190 cm)	150	22	464458

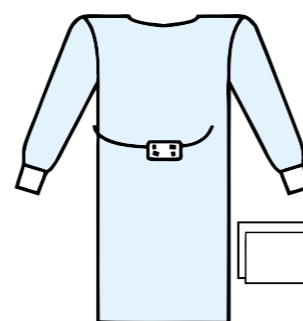

### Special Gowns/HP with bacteria and fluidproof interior reinforcement made of PE film and breathable interior sleeve reinforcement

Description	Length/cm	PU	Ref. no.
L	130	20	464414
XL	150	22	464417
XXL	170	18	464430

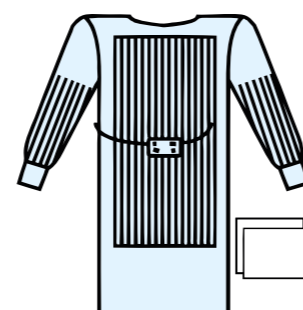

### Special Gowns/HP with bacteria and fluidproof exterior reinforcement made of PE film

Description	Length/cm	PU	Ref. no.
XL	150	24	464415
XXL	170	24	464418

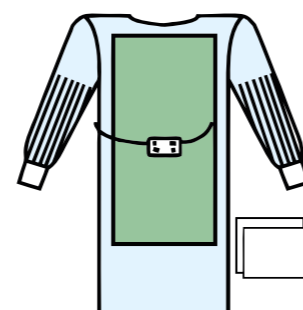

### OR Gown Pack, reinforced **563810**

PU: 6 packs

Description	Size or length/cm	Qty.	Ref. no.
Medinop overwrap	85 x 100	1	628510
OR gowns, spunlace, non-reinforced	L = 130	1	464413
OR gowns, spunlace, reinforced	XL = 150	4	464417
OR gowns, spunlace, reinforced	XXL = 170	1	464430

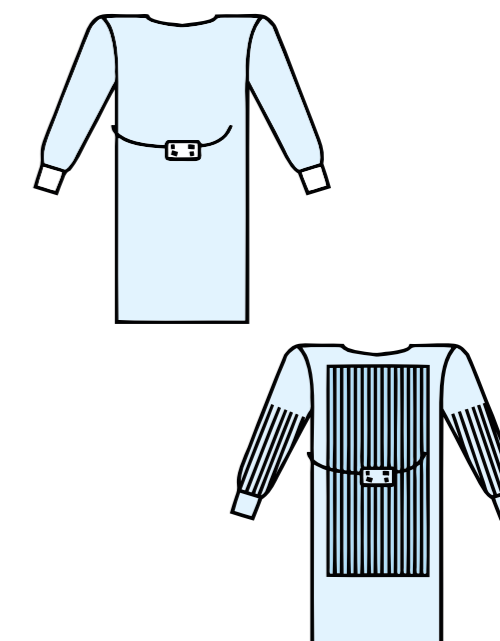

HP: fulfils the requirements of EN 13795 for High Performance  
 SP: fulfils the requirements of EN 13795 for Standard Performance

## OR Gowns Standard/Reinforced

**Gowns made of Mediwell light** SMMMS non-woven 47g/m<sup>2</sup>, breathable, highly comfortable to wear, fluid-repellent; each gown is supplied with **two 30 x 40 cm hand towels**

### Standard Gowns/SP non-reinforced

Description	Length/ cm	PU	Ref. no.
L, non-reinforced	135	28	464472
XL, non-reinforced	150	26	464473
XL <del>XL</del> , SMMMS reinforced	150	26	464475

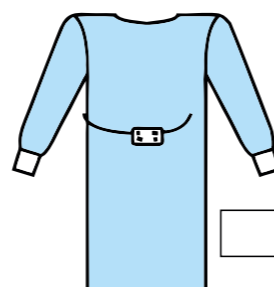

### TUR Gown/HP non-woven yoke section

Description	Length/ cm	PU	Ref. no.
L/XL	140	26	464455
XL	150	26	464428



### Sleeve Protectors, Mediwell super

PU: 210 pcs.

Description	Size/cm	Qty./ disp.	Ref. no.
2-ply, with cuff	22.5 x 57	35	582052

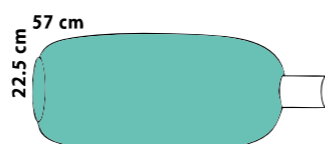

HP: fulfill the requirements of EN 13795 for High Performance  
SP: fulfill the requirements of EN 13795 for Standard Performance

**Gowns made of Mediwell light** SMMMS non-woven, breathable, textile-like structure, fluid-repellent; each gown is supplied with **two 30 x 40 cm hand towels**

### Standard Gowns/SP non-reinforced

Description	Length/ cm	PU	Ref. no.
M	120	34	464431
L	130	30	464433
XL	150	28	464436
XXL	170	26	464491

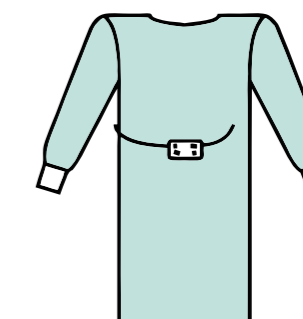

### Special Gowns/SP with interior SMMMS reinforcement

Description	Length/ cm	PU	Ref. no.
L	130	30	464434
XL	150	28	464437
XXL	170	24	464492

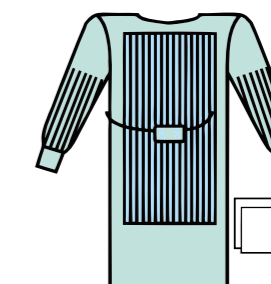

### Standard Gowns/SP with bacteria and fluidproof interior reinforcement

Description	Length/ cm	PU	Ref. no.
XL	150 cm <del>120</del>	24	464438
XXL	170 cm <del>140</del>	22	464439

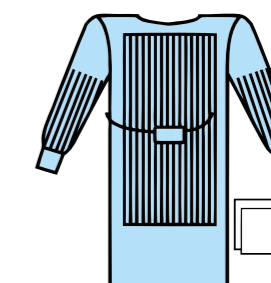

### Gown Pack standard **563840** delete PU:14 packs

Description	Size or Length/ cm	Qty.	Ref. no.
Medinop overwrap	85 x 100	1	628510
OR Gown, SMS, non-reinforced	XL = 150	3	464436

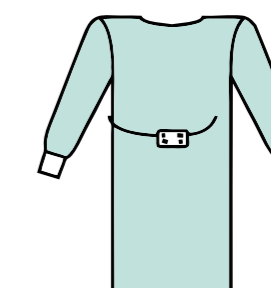

HP: fulfill the requirements of EN 13795 for High Performance  
SP: fulfill the requirements of EN 13795 for Standard Performance



## Protection Products (Non-sterile)



Protection covers and sheets, as well as aprons supplement our product portfolio and fulfil the requirements of the highest hygiene safety. In addition to standard articles, we provide complete and individual solutions tailored to the specific needs of our customers.

Our scrubs clothing contributes towards the protection of patients, personnel and visitors.



# Protection Products (Non-sterile)

## Scrub Suits/Non-Woven Jackets

**Scrub Suits, Mediwell soft and Mediwell 43 (SMS) tunics with press stud and 3-pocket trousers with tie waists and 2 back pockets**

PU: 4 x 25 pcs.

Description	Size/cm	SMS 43 Ref. no.	Soft Ref. no.
Size S, tunic	52 x 70	<del>469940</del>	469930
Size S, trousers	40 x 96	<del>469941</del>	469931
Size M, tunic	57 x 72	469942	469932
Size M, trousers	48 x 106	469943	469933
Size L, tunic	63 x 72	469944	469934
Size L, trousers	54 x 112	469945	469935
Size XL, tunic	67 x 75	469946	469936
Size XL, trousers	60 x 120	469947	469937
Size XXL, tunic	70 x 76	469948	469938
Size XXL, trousers	66 x 125	469949	469939

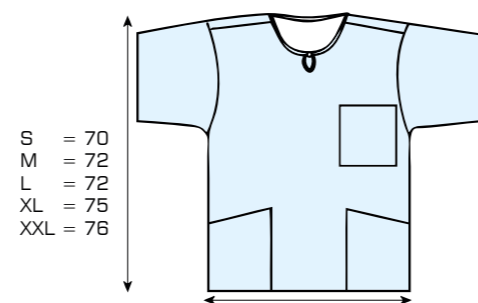

S = 52  
M = 57  
L = 63  
XL = 67  
XXL = 70

S = 52  
M = 57  
L = 63  
XL = 67  
XXL = 70

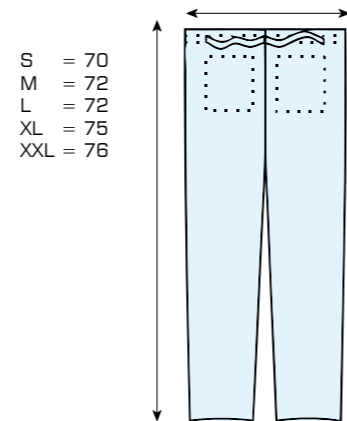

### Non-Woven Jackets

**Mediwell soft with press studs and 2 pockets**

PU: 50 pcs.

Description	Length/cm	Qty.	Ref. no.
Size M	72	1	469950
Size L	74	1	469951
Size XL	76	1	469952

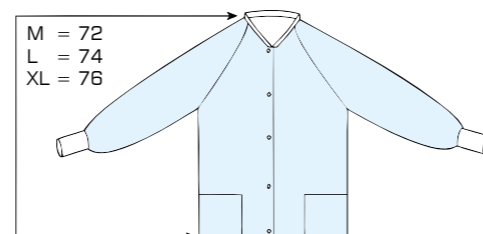

## Protection/Visitor Gown

### Protection Gown **464468**

**PP spunbond**

PU: 100

Description	Length/cm
Colour: light blue, with tie belt, OR gown folding, knitted cuffs	125

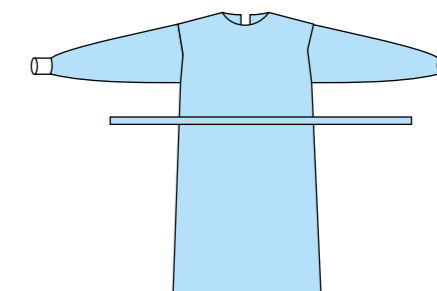

### Protection Gown **465521** delete

**SPP non-woven fabric with PE lamination on front and arms**

PU: 100

Description	Length/cm
Colour: yellow, velcro at the neck and tie around the waist, knitted cuffs	140

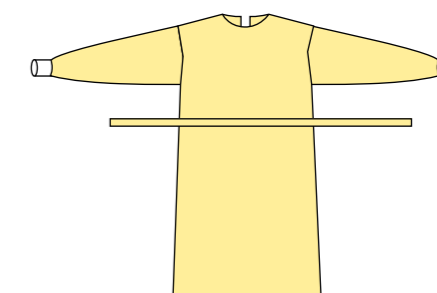

### Visitor Gown **465522** delete

**SPP non-woven fabric**

PU: 100

Description	Length/cm
Colour: purple, velcro at the neck and tie around the waist, knitted cuffs	130

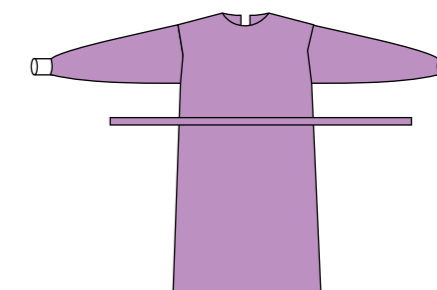

### Visitor Gown **465523**

**SPP non-woven fabric**

PU: 100

Description	Length/cm
Colour: light green, velcro at the neck and tie around the waist, elastic cuffs	115

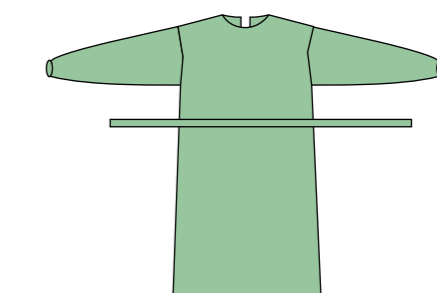

# Protection Products (Non-sterile)

## Accessory

not in the print catalogue  
**Aerobag®**  
**Waste Treatment Sacks**  
 PU: 200

**BYC186210**

Description	Size/cm	PU
Steam sterilisation temperatur resistant up to 134°, hygienic disposal of infectious waste with steam indicator. 60 l netto capacity. Material 80% PP-PA-PP, 20% non-woven plastic material.	65 x 100	200

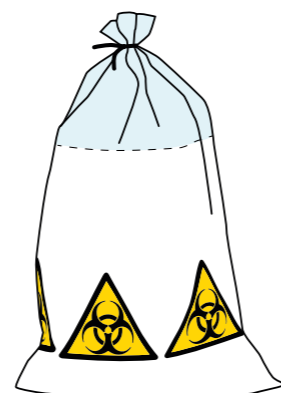

not in print catalogue

### uvex - Autoclavable Safety Eyewear

Description	PU	Ref. no.
Spectacles uvex super fit CR	5	9178.500
Protective goggles uvex super f OTG CR	5	9169.500
Face Shield 9706 CA	1	9706.514

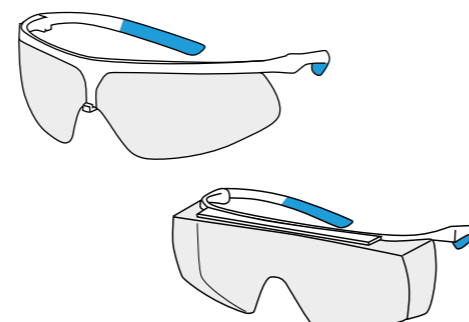

not in the print catalogue

### OR-table Sheet curea 150 **692180-9**

Description	Size/cm	PU
OR-table sheet and patient transfer device, non-sterile	210 x 80	20
Absorbent area	200 x 60	

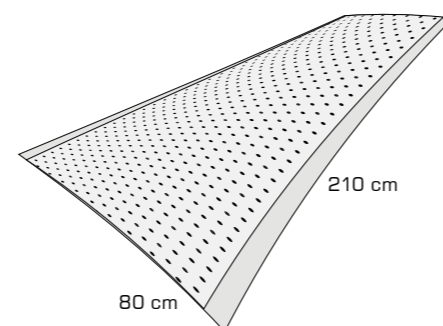

not in print catalogue

### Absorbent Floor Mat curea Liquimat standard **697536-9**

Description	Size/cm	PU
absorbent on both sides, absorbent capacity up to 7 litres of fluids, non-sterile	75 x 36	100

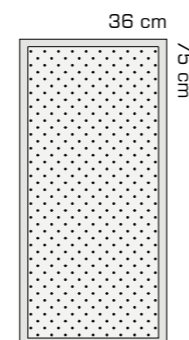

also available in 116 x 76 cm

## Protection Sheets/Aprons/Examination Couch Covers

### Medinop

Protective sheets	Qty. disp. or inliner/PU	Format/cm	Ref. no.
Protective sheets	700	37.5 x 40	623840
Protective sheets	700	45 x 75	624575
Protective sheets	500	60 x 75	626075
Protective sheets	400	75 x 90	627590
Protective sheets	200	75 x 140	627814
Protective sheets	150	75 x 175	627818
Protective sheets	150	75 x 200	627820
Protective sheets	125	75 x 210	627821
<del>Protective sheets</del>	150	85 x 175	628518 X delete
Protective sheets	100	85 x 210	628521

Examination couch covers	Qty./PU	Format/cm x m	Ref. no.
2-ply, white, on rolls, perforated every 28 cm	10	39 cm x 50 m	773950
2-ply, white, on rolls, perforated every 28 cm	10	44 cm x 50 m	774450
2-ply, white, on rolls, perforated every 28 cm	10	50 cm x 50 m	775050
<del>2-ply, white, on rolls, perforated every 28 cm</del>	10	55 cm x 50 m	775550 X delete
2-ply, white, on rolls, perforated every 28 cm	10	59 cm x 50 m	775950
2-ply, white, on rolls, perforated every 28 cm	8	74 cm x 50 m	777450

Aprons	Qty. disp. or inliner/PU	Format/cm	Ref. no.
White PE film, in dispensers	75 / 600	75 x 110	407511
White PE film, in dispensers	75 / 600	75 x 130	407513
White PE film, in dispensers	75 / 450	75 x 150	407515
White PE film, in dispensers	75 / 450	75 x 170	407517
Mediwell, 2-ply, in bundles à 50 pcs.	400	75 x 110	417511
Mediwell, 2-ply, in bundles à 50 pcs.	300	75 x 130	417513
Mediwell, 2-ply, in bundles à 50 pcs.	300	75 x 150	417515
Mediwell, 2-ply, in bundles à 50 pcs.	250	75 x 170	417517

**Medinop** is a 2-ply material made of 100% virgin, oxygen-bleached, white tissue and transparent PE film. It is soft, very drapeable, absorbent, impermeable to fluids and bacteria, rub-resistant and extremely suitable for use as a pack overwrap with a secondary application as a sterile field or bottom/protective sheet.

Product	Page(s)	Product	Page(s)	Product	Page(s)	Product	Page(s)
Absorbent Floor Mat	116	Examination Couch Covers	117	Pacemaker Drape	35	TUR Gowns	61, 110
Adhesive Drapes	16, 17, 80, 92	Extremity Drapes	41, 81, 88	Paediatric Drapes/Pack	80-81	TUR Drapes	56, 60, 90
Adhesive Drapes with special adhesive for sensitive skin	18	Extremity Drapes "small"	48, 88	Paediatric/ENT Split Sheet	74	TUR Packs	58, 90
Angiography Drapes	36-37	Extremity Packs	42	Perineal Drape	105	Turban Drape	74
Aperture Drapes	14, 76, 89, 93, 95	Eye Drapes	75-76	Pfannenstiel Drape/Pack	65	Under Buttocks Drape	68-69, 91
Aprons	117	Femoral Radial Angiography Drape	37	Pillowcase Cover	104	Universal Pack super	24
Armrest covers	77, 102	Film Pouch	103	Plain Drapes	12-13, 92	Universal Pack, paediatrics	24, 80
Arthroscopy Drapes	43, 87	Fluid Collection Pouches	51, 61, 98	Protection Gowns	115	Universal Pack, standard	24, 84
Arthroscopy Drapes "small"	43	Fluid Collection Pouches for Arthroscopies	51	Protective Sheets	117	Universal Pack, super+	25
Arthroscopy Packs	44-45, 86-87	Foot Covers	35, 100	Rectal Shield	61	Universal Packs	24-25
Arthroscopy Pack with Fluid Collection Pouch	44	GYN Drape/Pack	64	Rectum Drape/Pack	27	Universal Urology Drape	57
Baby Sheet	67	GYN/LAP Drapes/Pack	68	Rectum Drape with Leggings	27	Urology Drapes	56-57
Back Table Covers	21	GYN/URO Leggings	100	Safety Eyewear uvex, autoclavable	116	Urology Packs	58
Bypass Packs	33	GYN-TVT Drape with leggings	57, 64	Scrub Suits	114	Variable Aperture Drapes	14, 95
Camera Tube Covers	51, 101	Hand Surgery Drapes	47, 87	Shoulder Drape/Pack "Beach Chair"	46	Varicose Vein Drape	35
Cardio/Angiography Drapes	34	Hand/Foot Drapes/Pack	48, 88	Shoulder Split Sheet Packs	46, 85	Velcro Strip	51, 99
Cardio/Thoracic Drapes	32	Hip Drape/Pack	49	Sleeve Protectors	100	Vertical Isolation Drapes/Packs	50
Cardiovascular/Bypass Pack	33	Hybrid Drapes	34	Split Sheet Packs	29, 40, 85, 95	Visitor Gown	115
Craniotomy Pack	72	Image Intensifier Covers and Packs	52, 101	Split Sheet with film side strips	20	Waste Treatment Sacks	116
C-Section Drapes	66-67	Incision Film	99	Split Sheet with leggings	59	X-Ray Cassette Cover	102
C-Section Pack, standard	66	Laminectomy Drapes/Pack	73	Split Sheet with rectal fenestration and leggings	59		
CYST Drape	60, 68	Lead Window Cover	103	Split Sheet, bilateral	19		
CYST Pack	60, 69, 90	Leggings	61, 69, 90	Split Sheet, paediatric	81		
DaVinci Drape, T-Form	59	Mayo Stand Covers	21	Split Sheets	19-20, 40		
Diathermy Pouches	94, 98	MIS Drapes/Pack	26	Split Aperture Drape	20, 61		
Dual Extremity Drape	48	Neurosurgery Drapes	72	Standcover for bowl	105		
Elastic Inlets, non-steril	52, 105	Non-Woven Jackets	114	Stockinettes	53, 94, 100		
ENT Drapes	74	OR Gowns, standard/reinforced	108-111	Stool Covers	53, 77, 102		
Epidural Drapes	15, 16	OR Plain Drapes, rolled	104	Strumectomy Packs	28		
Equipment Covers	103	OR-table Sheet	116	Surgical Suture Bag	104		
		OR Tapes	53, 74, 94, 99	Tie Gowns	77		



#### About Our Production

Welcome to STERIL SAGLIK URUNLERI, your number one source for all things disposable coverall , and medical products. We're dedicated to production you the very best of medical products, with an emphasis on.

Founded in 2011 by Zeynel A. Savrun, STERIL SAGLIK URUNLERI has come a long way from its beginnings in Adana Turkey. When Zeynel A. Savrun first started out, his passion for eco-friendly sterilization products drove them to start their own business.

We hope you enjoy our products as much as we enjoy offering them to you. If you have any questions or comments, please don't hesitate to contact us.

Sincerely,



**STERIL SAGLIK URUNLERI**  
ZIYAPASA MH 67132 SOK GULMEN  
APT ASMA K D:1  
SEYHAN, ADANA, TURKEY, 0100  
[www.sterilsaglik.com](http://www.sterilsaglik.com)